

# DIE ALTERNATIVE

THE ALTERNATIVE  
L'ALTERNATIVE  
L'ALTERNATIVA

**2024**

## WEXO Präzisionswerkzeuge GmbH

Siemensstraße 13  
61352 Bad Homburg – Germany

Telefon: +49 (0) 6172 106 – 206

Telefax: +49 (0) 6172 106 – 213

Internet: <http://www.wexo.com>

E-Mail: [verkauf@wexo.com](mailto:verkauf@wexo.com)



Änderungen jeder Art oder Druckfehler von technischen Daten berechtigen nicht zu Ansprüchen. Bildliche Darstellungen sind nicht verbindlich.

Nachdruck von Text und Bildern, auch auszugsweise, ist ohne unsere Genehmigung nicht gestattet.



Changes of any kind, or printing errors regarding technical details, do not justify any claims. All pictures are without obligation.

Reprinting of text or pictures, or extracts thereof, is not allowed without our prior permission.



Des changements de toute sorte ou des erreurs d'impression éventuelles de données techniques ne justifient aucune réclamation. Des présentations figuratives ne font pas foi.

La reproduction de textes et de photos, même par extrait, n'est pas autorisée sans notre accord préalable.



Modifiche di ogni tipo o errori di stampa di dati tecnici non danno diritto a reclami. Le rappresentazioni grafiche non sono impegnative.

Non è permessa la riproduzione di testi o figure, anche parzialmente, senza la nostra autorizzazione.

	
<b>Gewindewerkzeuge / Threading tools / Outils de filetage / Utensili di filettatura</b>	<b>5</b>
Schnittdatenempfehlung / Recommended cutting data / Paramètres de coupe / Parametri di taglio	8
Gewindebohrerkassetten mit Kernlochbohrern / Tap cases with drills / Coffrets de tarauds avec forets d'avant trou / Cassette di maschi con relative punte per prefori	22
<b>Spiralbohrer / Twist drills / Forets / Punta</b>	<b>23</b>
Schnittdatenempfehlung / Recommended cutting data / Paramètres de coupe / Parametri di taglio	32
<b>Fräser / End mills / Fraises / Frese</b>	<b>47</b>
Schnittdatenempfehlung / Recommended cutting data / Paramètres de coupe / Parametri di taglio	61
<b>Info</b>	<b>73</b>
Kernlochtabelle / Tapping drill sizes / Groupes de matières / Gruppi materiali	73
Härtevergleichstabelle/ Hardness comparison table / Tableau de comparaisons de duretés / Tabella di comparazione delle durezze	76
Werkstoffübersicht / Work material overview / Index-Groupes de matières / Panoramica die materiali	77
Werkstoffgruppen / Classification of work / Goupes de matières / Gruppi materiali	79
Kurzzeichenerklärung / Explanation of symbols / Explication des symboles / Spiegazione die simboli	85
<b>Allgemeine Geschäftsbedingungen / General sales conditions / Conditions générales de vente / Condizioni generali di vendita</b>	<b>87</b>

# SELECT/LINE

by WEXO®

SELECT/TAP

SELECT/DRILL

SELECT/MILL



## Ihr Vorteil

Mit der Produktauswahl in dieser Broschüre können wir bei WEXO® die drei wichtigsten Forderungen unserer Kunden in idealer Weise vereinen.

### Preis:

Die Fertigung ausgewählter und bewährter Werkzeuge in großen Stückzahlen auf hochmodernen Präzisions-Schleifmaschinen führt zu einer deutlichen Steigerung der Produktivität. Der mit der Produktivitätssteigerung verbundene Preisvorteil wird in vollem Umfang an die Kunden weitergegeben.

### Qualität:

Durch den Einsatz ausgewählter Schneidstoffe mit auf die Anwendung hin optimierter Oberflächenveredelungen, die Fertigung auf hochmodernen Präzisions-Schleifmaschinen und durchgängige Kontrollmechanismen ist dieses Produktangebot ein Beweis für gelebte Qualität

**Made by WEXO®.**

### Verfügbarkeit:

Ein Höchstmaß an Verfügbarkeit wird durch die Fertigung großer Lose unserer Werkzeuge erreicht. Prüfen Sie uns! Bestellen Sie noch heute per Telefon, Fax oder E-Mail und Sie können schon morgen mit den Werkzeugen Ihre Fertigung rationalisieren.



## Your benefit

Our product range has enabled us to unify our customers' three key purchasing criteria.

### Price:

The production of tools in large quantities using state-of-the-art precision grinding machines has greatly increased our productivity, a benefit we are passing on to our customers' manufacturing processes in the form of competitive pricing.

### Quality:

The use of selected cutting material with an application-specific surface finish, the production using state-of-the-art grinding machines, and end-to-end total quality control, demonstrate that our product range is quality **Made by WEXO®.**

### Availability:

Availability is guaranteed by manufacturing in large batches, thereby maximising flexibility for our customers. Try WEXO® today and order by telephone, fax or email and tomorrow you will be in a position to rationalise your manufacturing processes using the tools.



## Vos avantages

Avec la sélection de produits dans cette brochure WEXO® a pu unir 3 exigences de notre clientèle.

### Prix:

La production de masse sur des machines ultramodernes et précises permet une nette amélioration de la productivité. Vous profitez complètement de cet avantage de prix obtenu grâce à ces critères.

### Qualité:

En utilisant des matières premières spécifiques et des revêtements optimisés, des machines ultramodernes et des

mécanismes de contrôle permanents, les produits de cette brochure prouvent la qualité connue **Made by WEXO®.**

### Disponibilité:

Nous vous garantissons un maximum de disponibilité grâce à nos lots de production. Passez encore aujourd'hui votre commande soit par téléphone, fax ou courrier électronique et dès demain vous rationalisez votre production avec nos outils.



## Il vostro vantaggio

Con la selezione dei prodotti in questo catalogo, siamo in grado di combinare le tre principali richieste dei nostri clienti in un modo ideale per WEXO®.

### Prezzo:

La produzione di utensili in grandi quantità, utilizzando rettifiche moderne, ha notevolmente incrementato la produttività e questo vantaggio noi lo passiamo ai nostri clienti sotto forma di prezzo competitivo.

### Qualità:

L'uso di materiali da taglio selezionati con finiture superficiali specifiche, macchine moderne e un controllo continuo, ci fanno affermare che è qualità **MADE by WEXO®.**

### Disponibilità:

La disponibilità è garantita del fatto che gli utensili vengono prodotti in grandi lotti e consentono ai nostri clienti la massima flessibilità. Prova WEXO oggi, ordina al telefono, via fax o via e-mail ti renderai conto di come potrai razionalizzare i tuoi processi produttivi.





**SELECT/TAP**  
by WEXO<sup>®</sup>

**SELECT/TAP**  
by WEXO<sup>®</sup>



Übersicht Maschinengewindebohrer / Schnittwertempfehlung  
Overview of taps / Recommended cutting data  
Aperçu de tarauds / Paramètres de coupe  
Programma maschi a macchina / Parametri di taglio consigliati

8

**M** **Typ N** **ISO 2 6H** **HSSE** **DIN 13** **M 3 – M12** **11**

 NB00  NC15  
 NC40



**M** **Typ N** **ISO 2 6H** **HSSE** **DIN 371** **M 3 – M10** **DIN 376** **M12 – M30** **11**

 NC00

**M** **Typ N** **ISO 2 6H** **HSSE** **DIN 371** **M 3 – M10** **DIN 376** **M12 – M30** **12**

 NB00  NC40  
 NB00VP  NC40VP  
 NB00TI  NC40TI  
 NB00TC  NC40TC



**M** **Typ VA** **ISO 2 6H** **HSSE** **DIN 371** **M 2 – M10** **DIN 376** **M12 – M30** **13**

 VAB00  VAC40  
 VAB00VP  VAC40VP  
 VAB00TI  VAC40TI  
 VAB00TC  VAC40TC































**M** **Typ GG** **6HX** **HSSE** **DIN 371** **M 3 – M10** **DIN 376** **M12 – M30** **14**

 GGC00TC

**M** **Typ AL** **ISO 2 6H** **HSSE** **DIN 371** **M 3 – M10** **DIN 376** **M12 – M20** **15**

 ALB00  ALC45

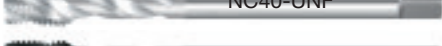

M	Typ H	ISO 2 6H	HSSE- PM	HSSE	DIN 371	M 3 – M10	DIN 376	M12 – M30	16	
										
										
										
M	Typ UNI	6HX	HSSE	DIN 2174	M 3 – M16				17	
										
										
MF	Typ N	Typ VA	ISO 2 6H	HSSE	DIN 374	M 4 x 0,5 – M20 x 1,5				18
										
G	Typ N	Typ VA	HSSE	DIN 5156	G1/8" – G2"				19	
										
UNC	Typ N	Typ VA	2B	HSSE	DIN 2184-1	UNC #5-40 – UNC 1"-8				20
										
UNF	Typ N	Typ VA	2B	HSSE	DIN 2184-1	UNF #5-44 – UNF 1"-12				21
										
<p>Gewindebohrerkassetten mit Kernlochbohrern Tap cases with drills Coffrets de tarauds avec forets d'avant trou Cassetta di Maschi con relative Punta per prefori</p>									22	
										

Übersicht Maschinengewindebohrer / Schnittwertempfehlung [m/min]  
Overview of taps / Recommended cutting data [m/min]  
Aperçu de tarauds / Paramètres de coupe [m/min]  
Programma maschi a macchina / Parametri di taglio consigliati [m/min]

		DIN 352	DIN 371	DIN 374	DIN 376	DIN 2184-1	DIN 5156					
Katalog-Nr. · Catalogue no. · Catalogue n° · Nr. di catalogo		NB00/NC00	NC15/NC40	NB00VP	NC40VP	NB00TI	NC40TI	NB00TC	NC40TC	VAB00	VAC40	
Schneidstoff · Cutting material · Matériau de coupe · Materiale di taglio		HSSE	HSSE	HSSE	HSSE	HSSE	HSSE	HSSE	HSSE	HSSE	HSSE	
Anschnitt · Chamfer · Entrée de coupe · Imbocco		B / C	C	B	C	B	C	B	C	B	C	
Toleranz · Tolerance · Tolérance · Tolleranza		–	–	ISO 2 (6H)	ISO 2 (6H)	ISO 2 (6H)	ISO 2 (6H)	ISO 2 (6H)	ISO 2 (6H)	ISO 2 (6H)	ISO 2 (6H)	
Beschichtung · Coating · Revêtement · Rivestimento		–	–	VP	VP	TIN	TIN	TiCN	TiCN	–	–	
Gewindeart · Type of thread · Type de filet · Tipo di filetto		1/1+2	1+2/2	1	2	1	2	1	2	1	2	
Werkstoffgruppen · Classification of work materials · Groupes de matériaux · Gruppo materiali	Katalogseite · Catalogue page · Page du catalogue · Pagina catalogo	M	11/12	11/12	12	12	12	12	12	12	13	13
		MF	18	18								
		G	19	19								
		UNC	20	20								
		UNF	21	21								
<b>1 Stähle · Steels · Aciers · Acciai</b>												
1.1/1.2	8–12	8–10	10–15	8–12	15–18	12–15	18–22	15–18	8–12	6–10		
1.3	8–10	6–10	10–12	8–10	12–15	10–12	15–18	12–15	8–10	6–8		
1.4.1/1.5.1									6–8	5–6		
1.4.2/1.5.2									6–8	5–6		
1.6									5–6	4–5		
<b>2 Gusseisen · Grey cast iron · Fonte · Ghisa</b>												
2.1/2.2									10–12	8–10		
2.3/2.4									8–10	6–8		
<b>3 Kupfer/Kupferlegierungen · Copper/Copper alloys · Cuivre/Alliages de cuivre · Rame/Leghe di rame</b>												
3.1/3.3	12–15	10–12							12–15	10–12		
3.2	10–12	8–10							10–12	8–10		
3.4	10–12	8–10			15–18	12–15	18–22	15–18	10–12	8–10		
3.5									8–10	6–8		
3.6												
<b>4 Aluminium/Aluminiumlegierungen · Aluminium/Aluminium alloys · Aluminium/Alliages d'aluminium · Alluminio/Leghe di alluminio</b>												
4.1/4.2	20–26	18–22							20–26	18–22		
4.3/4.4	18–22	15–18			20–26	18–22	26–32	22–26	18–22	15–18		
4.5									15–18	12–15		
<b>5 Titan/Titanlegierungen · Titanium/Titanium alloys · Titane/Alliages de titane · Titanio/Leghe di Titanio</b>												
5.1/5.2									3–4	2–3		
5.3/5.4												
5.5												
<b>6 Nickel/Nickellegierungen · Nickel/Nickel alloys · Nickel/Alliages de nickel · Nichel/Leghe di nichel</b>												
6.1	3–4	2–3			4–5	3–4	5–6	4–5	3–4	2–3		
6.2									3–4	2–3		
6.3												
<b>7 Kunststoffe · Plastics · Matières plastiques · Materiali plastici</b>												
7.1	20–26	18–22							20–26	18–22		
7.2									18–22	15–18		
7.3									18–22	15–18		











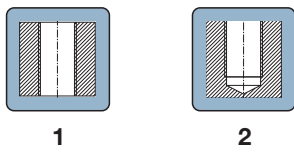





\* Fett = optimal geeignet · \* Bold = recommended use · en gras = optimal · \* grassetto = ideali per l'utilizzo



VAB00VP	VAC40VP	VAB00TI	VAC40TI	VAB00TC	VAC40TC	GGC00TC	ALB00	ALC45	HB00	HC40	HB00TC	HC40TC	
HSSE	HSSE	HSSE	HSSE	HSSE	HSSE	HSSE	HSSE	HSSE	HSSE	HSSE	HSSE	HSSE	HSSE
B	C	B	C	B	C	C	B	C	B	C	B	C	
-	-	ISO 2 (6H)	ISO 2 (6H)	ISO 2 (6H)	ISO 2 (6H)	6HX	ISO 2 (6H)	ISO 2 (6H)	ISO 2 (6H)	ISO 2 (6H)	ISO 2 (6H)	ISO 2 (6H)	ISO 2 (6H)
VP	VP	TiN	TiN	TiCN	TiCN	TiCN	-	-	-	-	TiCN	TiCN	
1	2	1	2	1	2	1/2	1	2	1	2	1	2	
13	13	13	13	13	13	14	15	15	16	16	16	16	
18	18												
19	19												
20	20												
21	21												
10-15	8-12	15-18	12-15	18-22	15-18								
10-12	8-10	12-15	10-12	15-18	12-15								
8-10	6-8	10-12	8-10	12-15	10-12				8-10	6-8	12-14	8-10	
8-10	6-8	10-12	8-10	12-15	10-12				8-10	6-8	12-14	8-10	
6-8	5-6	8-10	6-8	10-12	8-10								
12-15	10-12	15-20	12-15	20-25	15-20	18-22			16-20	12-16	18-24	16-20	
10-12	8-10	12-15	10-12	15-20	12-15	15-18			12-16	10-14	16-20	12-16	
				18-22	15-18		12-15	10-12					
12-15	10-12	15-18	12-15	18-22	15-18	15-18			12-16	10-14	16-20	12-16	
		15-18	12-15	18-22	15-18								
8-10	8-10	12-15	8-10	15-18	12-15	10-12			8-10	6-8	10-14	8-10	
						8-10			6-8	5-6	8-10	6-8	
				26-32	22-26		20-26	18-22					
		20-26	18-22	26-32	22-26								
15-18	12-15	18-22	15-18	22-26	18-22	22-26			16-20	12-16	18-24	16-20	
3-4	2-3								3-4	2-3			
3-4	2-3								3-4	2-3			
									2-3	2-3			
3-4	2-3	4-5	3-4	5-6	4-5								
3-4	2-3	4-5	3-4	5-6	4-5								
									2-3	1-2	3-4	2-3	
				26-32	22-26		20-26	18-22					
18-22	15-18	22-26	18-22	26-32	22-26	26-32			18-24	16-20	18-28	18-24	
18-22	15-18	22-26	18-22	26-32	22-26	26-32			18-24	16-20	18-28	18-24	

SELECT/TAP  
by WEXO<sup>®</sup>

Übersicht Maschinengewindebohrer und Innengewindeformer / Schnittwertempfehlung [m/min]  
Overview of taps and fluteless taps / Recommended cutting data [m/min]  
Aperçu de tarauds et tarauds à refouler / Paramètres de coupe [m/min]  
Programma maschi a macchina e a rullare / Parametri di taglio consigliati [m/min]

		DIN 352	DIN 371	DIN 374	DIN 376	DIN 2184-1	DIN 5156											
 <p>1                      2</p>																		
Katalog-Nr. · Catalogue no. · Catalogue n° · Nr. di catalogo		HB00-PM	HC15-PM	HB00TC-PM	HC15TC-PM	UC00	UC00TI	UC00TC	UC00SN	UC00SNTI	UC00SNTC							
Schneidstoff · Cutting material · Matériau de coupe · Materiale di taglio		HSSE-PM	HSSE-PM	HSSE-PM	HSSE-PM	HSSE	HSSE	HSSE	HSSE	HSSE	HSSE							
Anschnitt · Chamfer · Entrée de coupe · Imbocco		B	C	B	C	C	C	C	C	C	C							
Toleranz · Tolerance · Tolérance · Tolleranza		ISO 2 (6H)	ISO 2 (6H)	ISO 2 (6H)	ISO 2 (6H)	6HX	6HX	6HX	6HX	6HX	6HX							
Beschichtung · Coating · Revêtement · Rivestimento		–	–	TiCN	TiCN	–	TiN	TiCN	–	TiN	TiCN							
Gewindeart · Type of thread · Type de filet · Tipo di filetto		1	2	1	2	1/2	1/2	1/2	1/2	1/2	1/2							
Werkstoffgruppen · Classification of work materials · Groupes de matériaux · Gruppo materiali	Katalogseite · Catalogue page · Page du catalogue · Pagina catalogo	M	16	16	16	16	17	17	17	17	17	17	17	17	17	17	17	
		MF																
		G																
		UNC																
		UNF																
<b>1 Stähle · Steels · Aciers · Acciai</b>																		
1.1/1.2							12–22	15–28	18–35	12–22	12–28	12–28						
1.3								10–20	12–25		10–20	10–20						
1.4.1/1.5.1	12–15	10–12	15–18	12–15														
1.4.2/1.5.2	12–15	10–12	15–18	12–15														
1.6																		
<b>2 Gusseisen · Grey cast iron · Fonte · Ghisa</b>																		
2.1/2.2	22–26	18–22	26–32	22–26														
2.3/2.4	18–22	15–18	22–26	18–22														
<b>3 Kupfer/Kupferlegierungen · Copper/Copper alloys · Cuivre/Alliages de cuivre · Rame/Leghe di rame</b>																		
3.1/3.3							12–22	14–25		12–22	14–25							
3.2	18–22	15–18	22–26	18–22														
3.4										10–20	12–22							
3.5	12–15	10–12	15–18	12–15														
3.6	10–12	8–10	12–15	10–12														
<b>4 Aluminium/Aluminiumlegierungen · Aluminium/Aluminium alloys · Aluminium/Alliages d'aluminium · Alluminio/Leghe di alluminio</b>																		
4.1/4.2							12–22	18–30	22–40	12–22	18–30	22–40						
4.3/4.4									22–40				22–40					
4.5	22–26	18–22	26–32	22–26														
<b>5 Titan/Titanlegierungen · Titanium/Titanium alloys · Titane/Alliages de titane · Titanio/Leghe di Titanio</b>																		
4.1/4.2	5–6	3–5																
4.3/4.4	5–6	3–5																
4.5	3–5	2–4																
<b>6 Nickel/Nickellegierungen · Nickel/Nickel alloys · Nickel/Alliages de nickel · Nichel/Leghe di nichel</b>																		
6.1																		
6.2																		
6.3	3–4	2–3	4–5	3–4														
<b>7 Kunststoffe · Plastics · Matières plastiques · Materiali plastici</b>																		
7.1							15–25	18–30	22–40	15–25	18–30	22–40						
7.2	26–32	22–26	30–40	26–32														
7.3	26–32	22–26	30–40	26–32														

\* Fett = optimal geeignet · \* Bold = recommended use · en gras = optimal · \* grassetto = ideali per l'utilizzo

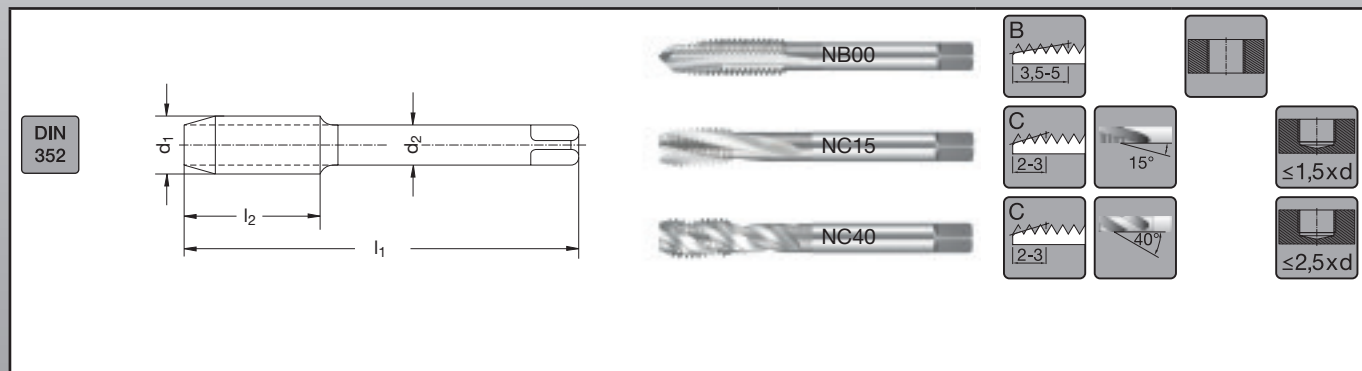
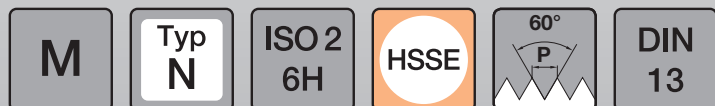

Katalog-Nr. <sup>W%</sup> Catalogue n° <sup>W%</sup>		Catalogue no. <sup>W%</sup> Nr. di catalogo <sup>W%</sup>							NB00 <sup>730</sup>		NC15 <sup>730</sup>		NC40 <sup>730</sup>	
d <sub>1</sub> [mm]	P [mm]	l <sub>1</sub> [mm]	l <sub>2</sub> [mm]	l <sub>3</sub> [mm]	d <sub>2</sub> [mm]	□ [mm]	z	∅ [mm]	Code 	€	Code 	€	Code 	€
M 3	0,5	40	9	-	3,5	2,7	3	2,5	600 180	9,85				
M 4	0,7	45	12	-	4,5	3,4	3	3,3	600 182	9,85				
M 5	0,8	50	13	-	6	4,9	3	4,2	600 183	10,25				
M 6	1	56	15	-	6	4,9	3	5	600 184	10,25				
M 8	1,25	63	18	-	6	4,9	3	6,8	600 186	13,50				
M 10	1,5	70	20	-	7	5,5	3	8,5	600 188	16,00				
M 12	1,75	75	23	-	9	7	3	10,2	600 190	21,25				
M 3	0,5	40	5	-	3,5	2,7	3	2,5			600 200	10,50	600 220	10,50
M 4	0,7	45	7	-	4,5	3,4	3	3,3			600 202	10,50	600 222	10,50
M 5	0,8	50	8	-	6	4,9	3	4,2			600 203	10,50	600 223	10,50
M 6	1	56	10	-	6	4,9	3	5			600 204	10,50	600 224	10,50
M 8	1,25	63	13	-	6	4,9	3	6,8			600 206	14,25	600 226	14,25
M 10	1,5	70	15	-	7	5,5	3	8,5			600 208	17,00	600 228	17,00
M 12	1,75	75	18	-	9	7	3	10,2			600 210	22,50	600 230	22,50

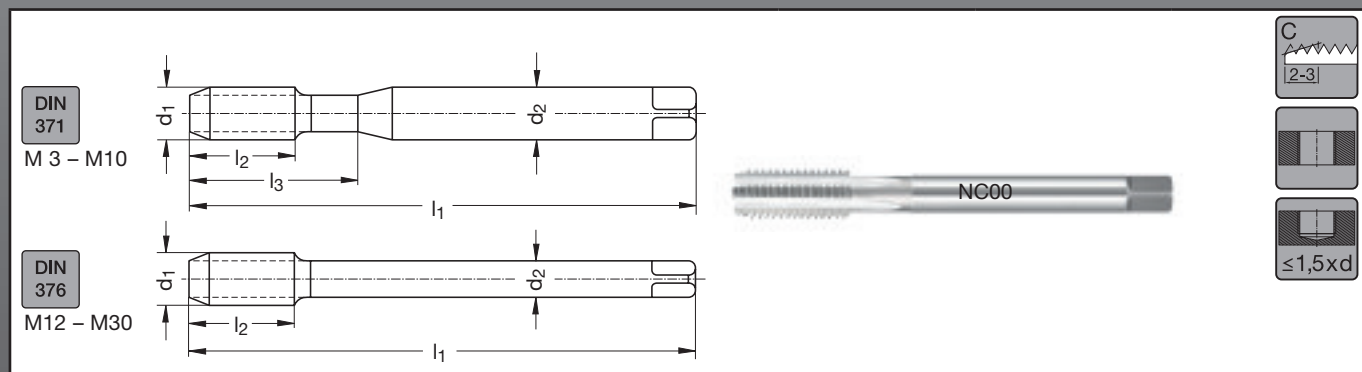

Katalog-Nr. <sup>W%</sup> Catalogue n° <sup>W%</sup>		Catalogue no. <sup>W%</sup> Nr. di catalogo <sup>W%</sup>							NC00 <sup>730</sup>	
d <sub>1</sub> [mm]	P [mm]	l <sub>1</sub> [mm]	l <sub>2</sub> [mm]	l <sub>3</sub> [mm]	d <sub>2</sub> [mm]	□ [mm]	z	∅ [mm]	Code 	€
M 3	0,5	56	9	18	3,5	2,7	3	2,5	600 240	9,85
M 4	0,7	63	12	21	4,5	3,4	3	3,3	600 242	9,85
M 5	0,8	70	13	25	6	4,9	3	4,2	600 243	10,25
M 6	1	80	15	30	6	4,9	3	5	600 244	10,25
M 8	1,25	90	18	35	8	6,2	3	6,8	600 246	13,50
M 10	1,5	100	20	39	10	8	3	8,5	600 248	16,00
M 12	1,75	110	23	-	9	7	3	10,2	600 260	21,25
M 14	2	110	25	-	11	9	3	12	600 261	25,75
M 16	2	110	25	-	12	9	3	14	600 262	33,00
M 18	2,5	125	30	-	14	11	3	15,5	600 263	43,75
M 20	2,5	140	30	-	16	12	3	17,5	600 264	50,50
M 22	2,5	140	30	-	18	14,5	3	19,5	600 265	66,00
M 24	3	160	36	-	18	14,5	4	21	600 266	71,00
M 27	3	160	36	-	20	16	4	24	600 267	85,00
M 30	3,5	180	40	-	22	18	4	26,5	600 268	112,00

M  
HSSE  
SELECT/TAP  
by WEXO<sup>®</sup>

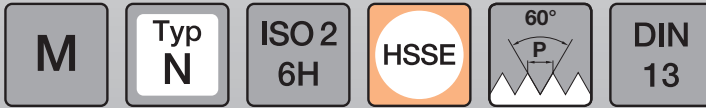

M

HSSE

SELECT/TAP  
by WEXO<sup>®</sup>

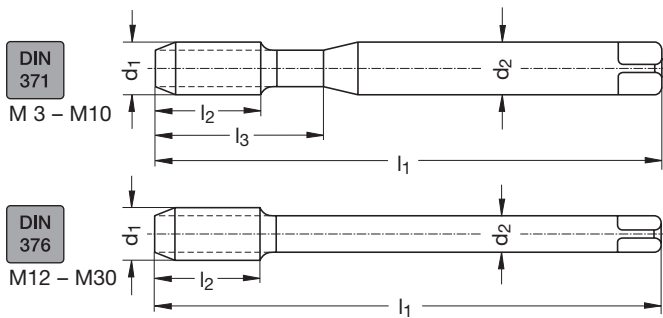

Katalog-Nr. <sup>W%</sup> Catalogue n° <sup>W%</sup>		Catalogue no. <sup>W%</sup> Nr. di catalogo <sup>W%</sup>							NB00 <sup>730</sup>		NB00VP <sup>730</sup>		NB00TI <sup>740</sup>		NB00TC <sup>740</sup>	
d <sub>1</sub> [mm]	P [mm]	l <sub>1</sub> [mm]	l <sub>2</sub> [mm]	l <sub>3</sub> [mm]	d <sub>2</sub> [mm]	□ [mm]	z	∅ [mm]	Code	€	Code	€	Code	€	Code	€
M 3	0,5	56	9	18	3,5	2,7	3	2,5	600 000	9,85	601 000	9,85	602 000	17,00	603 000	17,75
M 4	0,7	63	12	21	4,5	3,4	3	3,3	600 002	9,85	601 002	9,85	602 002	17,00	603 002	17,75
M 5	0,8	70	13	25	6	4,9	3	4,2	600 003	10,25	601 003	10,25	602 003	17,50	603 003	18,25
M 6	1	80	15	30	6	4,9	3	5	600 004	10,25	601 004	10,25	602 004	17,50	603 004	18,25
M 8	1,25	90	18	35	8	6,2	3	6,8	600 006	13,50	601 006	13,50	602 006	21,75	603 006	22,50
M 10	1,5	100	20	39	10	8	3	8,5	600 008	16,00	601 008	16,00	602 008	27,50	603 008	28,25
M 12	1,75	110	23	-	9	7	3	10,2	600 010	21,25	601 010	21,25	602 010	35,00	603 010	36,25
M 14	2	110	25	-	11	9	3	12	600 011	25,75	601 011	25,75	602 011	41,25	603 011	42,50
M 16	2	110	25	-	12	9	3	14	600 012	33,00	601 012	33,00	602 012	50,00	603 012	51,00
M 18	2,5	125	30	-	14	11	3	15,5	600 013	43,75	601 013	43,75	602 013	70,00	603 013	72,50
M 20	2,5	140	30	-	16	12	3	17,5	600 014	50,50	601 014	50,50	602 014	78,50	603 014	81,50
M 22	2,5	140	30	-	18	14,5	3	19,5	600 016	66,00	601 016	66,00	602 016	100,00	603 016	102,00
M 24	3	160	36	-	18	14,5	4	21	600 018	71,00	601 018	71,00	602 018	105,00	603 018	110,00
M 27	3	160	36	-	20	16	4	24	600 019	85,00	601 019	85,00	602 019	128,00	603 019	132,00
M 30	3,5	180	40	-	22	18	4	26,5	600 069	112,00	601 069	112,00	602 069	155,00	603 069	160,00

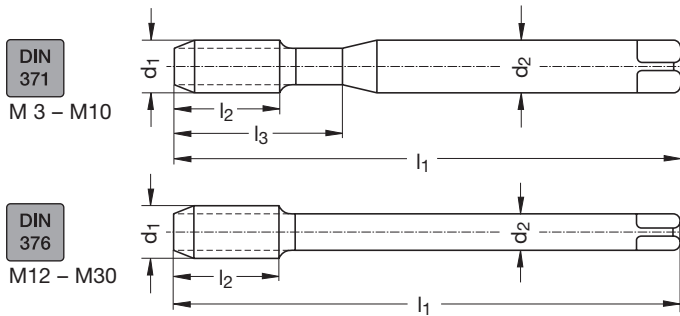

Katalog-Nr. <sup>W%</sup> Catalogue n° <sup>W%</sup>		Catalogue no. <sup>W%</sup> Nr. di catalogo <sup>W%</sup>							NC40 <sup>730</sup>		NC40VP <sup>730</sup>		NC40TI <sup>740</sup>		NC40TC <sup>740</sup>	
d <sub>1</sub> [mm]	P [mm]	l <sub>1</sub> [mm]	l <sub>2</sub> [mm]	l <sub>3</sub> [mm]	d <sub>2</sub> [mm]	□ [mm]	z	∅ [mm]	Code	€	Code	€	Code	€	Code	€
M 3	0,5	56	5	18	3,5	2,7	3	2,5	600 100	10,50	601 100	10,50	602 100	17,75	603 100	18,50
M 4	0,7	63	7	21	4,5	3,4	3	3,3	600 102	10,50	601 102	10,50	602 102	17,75	603 102	18,50
M 5	0,8	70	8	25	6	4,9	3	4,2	600 103	10,50	601 103	10,50	602 103	17,75	603 103	18,50
M 6	1	80	10	30	6	4,9	3	5	600 104	10,50	601 104	10,50	602 104	17,75	603 104	18,50
M 8	1,25	90	13	35	8	6,2	3	6,8	600 106	14,25	601 106	14,25	602 106	22,50	603 106	23,75
M 10	1,5	100	15	39	10	8	3	8,5	600 108	17,00	601 108	17,00	602 108	28,25	603 108	29,50
M 12	1,75	110	18	-	9	7	3	10,2	600 110	22,50	601 110	22,50	602 110	37,00	603 110	38,00
M 14	2	110	20	-	11	9	3	12	600 111	27,75	601 111	27,75	602 111	43,75	603 111	45,00
M 16	2	110	20	-	12	9	3	14	600 112	35,50	601 112	35,50	602 112	52,00	603 112	53,50
M 18	2,5	125	25	-	14	11	4	15,5	600 113	46,25	601 113	46,25	602 113	72,50	603 113	75,00
M 20	2,5	140	25	-	16	12	4	17,5	600 114	54,50	601 114	54,50	602 114	82,50	603 114	85,00
M 22	2,5	140	25	-	18	14,5	4	19,5	600 116	70,00	601 116	70,00	602 116	102,00	603 116	105,00
M 24	3	160	30	-	18	14,5	4	21	600 118	74,00	601 118	74,00	602 118	109,00	603 118	114,00
M 27	3	160	30	-	20	16	4	24	600 119	88,50	601 119	88,50	602 119	132,00	603 119	136,00
M 30	3,5	180	35	-	22	18	4	26,5	600 169	118,00	601 169	118,00	602 169	160,00	603 169	163,00



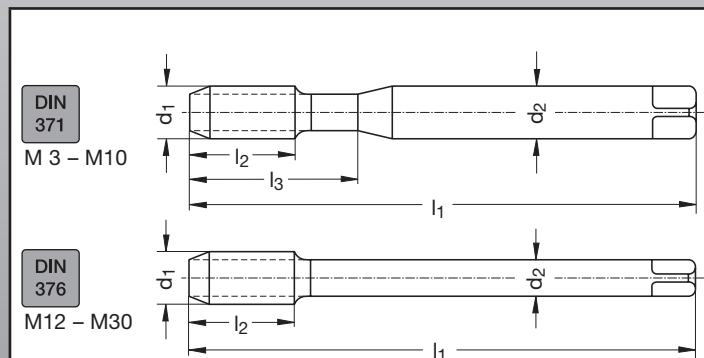
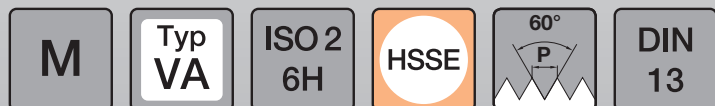

M

HSSE

Katalog-Nr. W% Catalogue n° W%		Catalogue no. W% Nr. di catalogo W%							VAB00 <sup>730</sup>		VAB00VP <sup>730</sup>		VAB00TI <sup>740</sup>		VAB00TC <sup>740</sup>	
d <sub>1</sub> [mm]	P [mm]	l <sub>1</sub> [mm]	l <sub>2</sub> [mm]	l <sub>3</sub> [mm]	d <sub>2</sub> [mm]	□ [mm]	z	Ø [mm]	Code	€	Code	€	Code	€	Code	€
M 2	0,4	45	9	-	2,8	2,1	2	1,6			601 092	14,25				
M 2,5	0,45	50	9	-	2,8	2,1	2	2,05			601 093	14,00				
M 3	0,5	56	9	18	3,5	2,7	3	2,5	600 020	11,00	601 020	11,00	602 020	18,25	603 020	19,25
M 4	0,7	63	12	21	4,5	3,4	3	3,3	600 022	11,00	601 022	11,00	602 022	18,25	603 022	19,25
M 5	0,8	70	13	25	6	4,9	3	4,2	600 023	11,00	601 023	11,00	602 023	18,25	603 023	19,25
M 6	1	80	15	30	6	4,9	3	5	600 024	11,00	601 024	11,00	602 024	18,25	603 024	19,25
M 8	1,25	90	18	35	8	6,2	3	6,8	600 026	15,00	601 026	15,00	602 026	23,25	603 026	24,25
M 10	1,5	100	20	39	10	8	3	8,5	600 028	17,75	601 028	17,75	602 028	29,25	603 028	30,00
M 12	1,75	110	23	-	9	7	3	10,2	600 030	23,25	601 030	23,25	602 030	37,00	603 030	38,00
M 14	2	110	25	-	11	9	3	12	600 031	31,50	601 031	31,50	602 031	47,00	603 031	48,25
M 16	2	110	25	-	12	9	3	14	600 032	36,50	601 032	36,50	602 032	52,50	603 032	55,00
M 18	2,5	125	30	-	14	11	3	15,5	600 033	51,00	601 033	51,00	602 033	77,00	603 033	79,50
M 20	2,5	140	30	-	16	12	3	17,5	600 034	56,00	601 034	56,00	602 034	82,50	603 034	85,00
M 22	2,5	140	30	-	18	14,5	3	19,5	600 036	76,50	601 036	76,50	602 036	109,00	603 036	112,00
M 24	3	160	36	-	18	14,5	4	21	600 038	78,00	601 038	78,00	602 038	114,00	603 038	118,00
M 27	3	160	36	-	20	16	4	24	600 039	98,00	601 039	98,00	602 039	143,00	603 039	150,00
M 30	3,5	180	40	-	22	18	4	26,5	600 071	128,00	601 071	128,00	602 071	170,00	603 071	173,00

SELECT/TAP  
by WEXO<sup>®</sup>

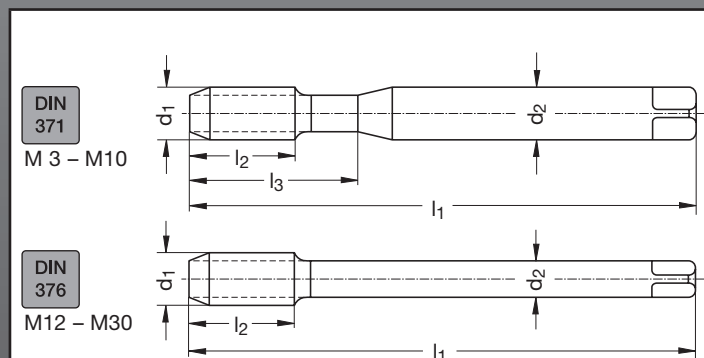

Katalog-Nr. W% Catalogue n° W%		Catalogue no. W% Nr. di catalogo W%							VAC40 <sup>730</sup>		VAC40VP <sup>730</sup>		VAC40TI <sup>740</sup>		VAC40TC <sup>740</sup>	
d <sub>1</sub> [mm]	P [mm]	l <sub>1</sub> [mm]	l <sub>2</sub> [mm]	l <sub>3</sub> [mm]	d <sub>2</sub> [mm]	□ [mm]	z	Ø [mm]	Code	€	Code	€	Code	€	Code	€
M 2	0,4	45	9	-	2,8	2,1	2	1,6			601 192	14,50				
M 2,5	0,45	50	9	-	2,8	2,1	2	2,05			601 193	14,25				
M 3	0,5	56	5	18	3,5	2,7	3	2,5	600 120	11,75	601 120	11,75	602 120	18,50	603 120	19,50
M 4	0,7	63	7	21	4,5	3,4	3	3,3	600 122	11,75	601 122	11,75	602 122	18,50	603 122	19,50
M 5	0,8	70	8	25	6	4,9	3	4,2	600 123	12,25	601 123	12,25	602 123	19,25	603 123	19,75
M 6	1	80	10	30	6	4,9	3	5	600 124	12,25	601 124	12,25	602 124	19,25	603 124	19,75
M 8	1,25	90	13	35	8	6,2	3	6,8	600 126	15,50	601 126	15,50	602 126	23,75	603 126	25,00
M 10	1,5	100	15	39	10	8	3	8,5	600 128	18,00	601 128	18,00	602 128	29,50	603 128	30,25
M 12	1,75	110	18	-	9	7	3	10,2	600 130	23,75	601 130	23,75	602 130	37,50	603 130	38,75
M 14	2	110	20	-	11	9	3	12	600 131	32,00	601 131	32,00	602 131	47,00	603 131	48,25
M 16	2	110	20	-	12	9	4	14	600 132	36,50	601 132	36,50	602 132	52,50	603 132	55,00
M 18	2,5	125	25	-	14	11	4	15,5	600 133	54,00	601 133	54,00	602 133	79,50	603 133	82,00
M 20	2,5	140	25	-	16	12	4	17,5	600 134	56,50	601 134	56,50	602 134	84,00	603 134	86,50
M 22	2,5	140	25	-	18	14,5	4	19,5	600 136	77,50	601 136	77,50	602 136	112,00	603 136	115,00
M 24	3	160	30	-	18	14,5	4	21	600 138	80,50	601 138	80,50	602 138	117,00	603 138	120,00
M 27	3	160	30	-	20	16	4	24	600 139	101,00	601 139	101,00	602 139	148,00	603 139	154,00
M 30	3,5	180	35	-	22	18	4	26,5	600 171	133,00	601 171	133,00	602 171	173,00	603 171	177,00



M

HSSE

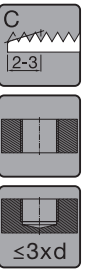
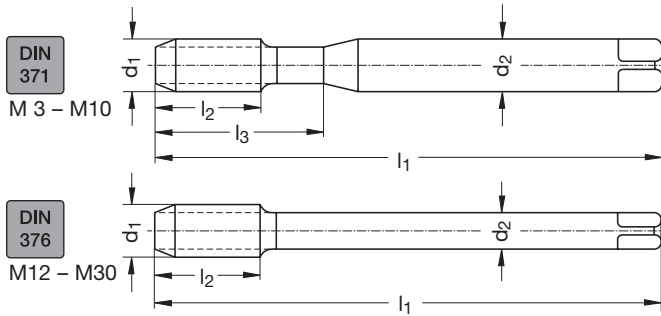

Katalog-Nr. <sup>W%</sup> Catalogue n° <sup>W%</sup>		Catalogue no. <sup>W%</sup> Nr. di catalogo <sup>W%</sup>		GGC00TC <sup>740</sup>						
				TiCN						
d <sub>1</sub> [mm]	P [mm]	l <sub>1</sub> [mm]	l <sub>2</sub> [mm]	l <sub>3</sub> [mm]	d <sub>2</sub> [mm]	□ [mm]	z	∅ [mm]	Code	€
M 3	0,5	56	9	18	3,5	2,7	3	2,5	603 080	19,50
M 4	0,7	63	12	21	4,5	3,4	3	3,3	603 082	19,50
M 5	0,8	70	13	25	6	4,9	3	4,2	603 083	19,75
M 6	1	80	15	30	6	4,9	3	5	603 084	19,75
M 8	1,25	90	18	35	8	6,2	4	6,8	603 086	28,00
M 10	1,5	100	20	39	10	8	4	8,5	603 088	32,25
M 12	1,75	110	23	-	9	7	4	10,2	603 090	42,50
M 14	2	110	25	-	11	9	4	12	603 091	50,00
M 16	2	110	25	-	12	9	4	14	603 092	61,00
M 18	2,5	125	30	-	14	11	4	15,5	603 093	78,50
M 20	2,5	140	30	-	16	12	4	17,5	603 094	96,00
M 22	2,5	140	30	-	18	14,5	4	19,5	603 095	117,00
M 24	3	160	36	-	18	14,5	4	21	603 097	121,00
M 27	3	160	36	-	20	16	4	24	603 098	142,00
M 30	3,5	180	40	-	22	18	4	26,5	603 099	175,00

by WEXO<sup>®</sup>  
**SELECT/TAP**

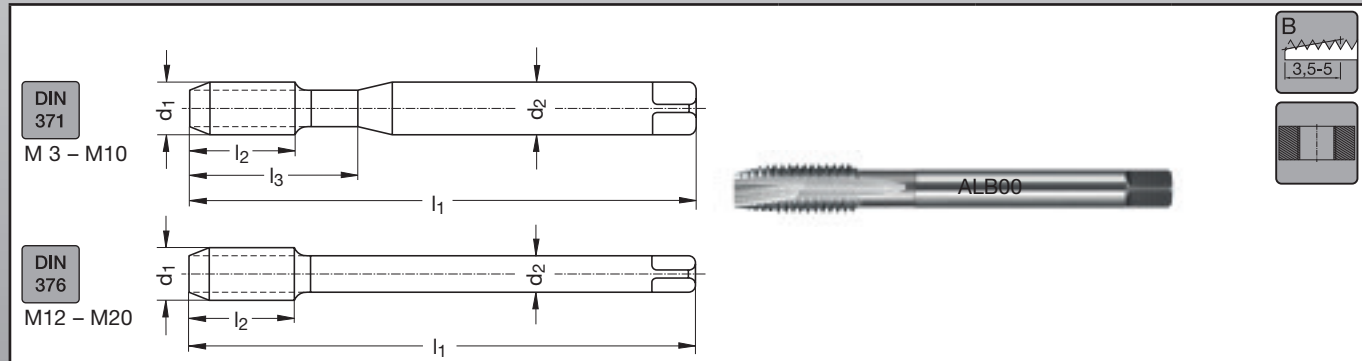
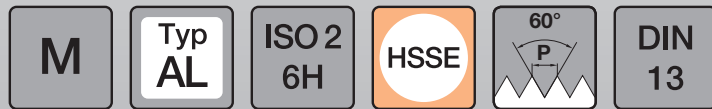

**M**  
**HSSE**

Katalog-Nr. <sup>W%</sup> Catalogue n° <sup>W%</sup>		Catalogue no. <sup>W%</sup> Nr. di catalogo <sup>W%</sup>		ALB00 <sup>730</sup>						
d <sub>1</sub> [mm]	P [mm]	l <sub>1</sub> [mm]	l <sub>2</sub> [mm]	l <sub>3</sub> [mm]	d <sub>2</sub> [mm]	□ [mm]	z	∅ [mm]	Code ✍	€
M 3	0,5	56	9	18	3,5	2,7	3	2,5	600 040	9,85
M 4	0,7	63	12	21	4,5	3,4	3	3,3	600 042	9,85
M 5	0,8	70	13	25	6	4,9	3	4,2	600 043	10,25
M 6	1	80	15	30	6	4,9	3	5	600 044	10,25
M 8	1,25	90	18	35	8	6,2	3	6,8	600 046	13,50
M 10	1,5	100	20	39	10	8	3	8,5	600 048	16,00
M 12	1,75	110	23	-	9	7	3	10,2	600 050	21,25
M 14	2	110	25	-	11	9	3	12	600 051	27,50
M 16	2	110	25	-	12	9	3	14	600 052	32,25
M 18	2,5	125	30	-	14	11	3	15,5	600 053	46,25
M 20	2,5	140	30	-	16	12	3	17,5	600 054	50,50

**SELECT / TAP**  
by WEXO<sup>®</sup>

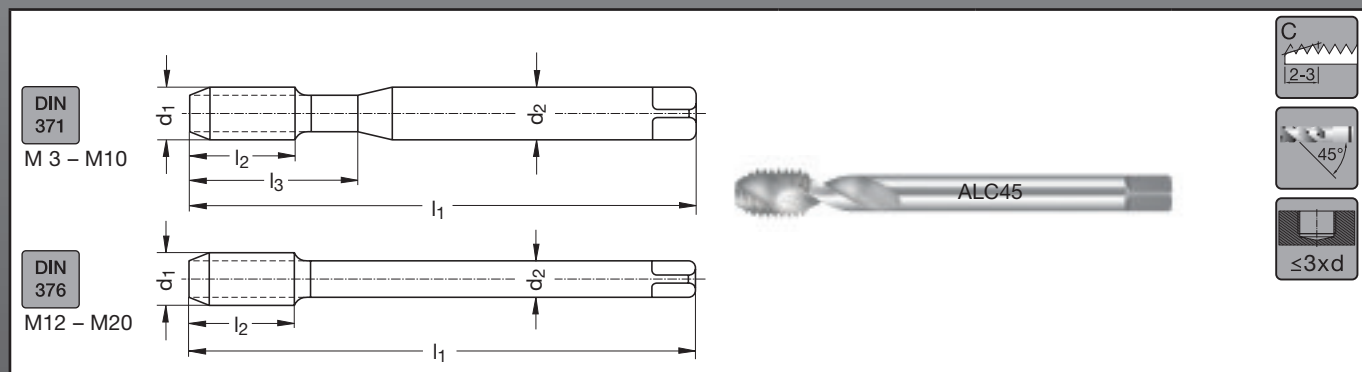

**C**  
2-3  
45°  
≤3xd

Katalog-Nr. <sup>W%</sup> Catalogue n° <sup>W%</sup>		Catalogue no. <sup>W%</sup> Nr. di catalogo <sup>W%</sup>		ALC45 <sup>730</sup>						
d <sub>1</sub> [mm]	P [mm]	l <sub>1</sub> [mm]	l <sub>2</sub> [mm]	l <sub>3</sub> [mm]	d <sub>2</sub> [mm]	□ [mm]	z	∅ [mm]	Code ✍	€
M 3	0,5	56	5	18	3,5	2,7	2	2,5	600 140	11,00
M 4	0,7	63	7	21	4,5	3,4	2	3,3	600 142	11,00
M 5	0,8	70	8	25	6	4,9	2	4,2	600 143	12,25
M 6	1	80	10	30	6	4,9	2	5	600 144	12,25
M 8	1,25	90	13	35	8	6,2	2	6,8	600 146	14,25
M 10	1,5	100	15	39	10	8	2	8,5	600 148	16,25
M 12	1,75	110	18	-	9	7	2	10,2	600 150	22,00
M 14	2	110	20	-	11	9	2	12	600 151	30,50
M 16	2	110	20	-	12	9	2	14	600 152	34,00
M 18	2,5	125	25	-	14	11	3	15,5	600 153	50,50
M 20	2,5	140	25	-	16	12	3	17,5	600 154	52,00



M

HSSE-PM

HSSE

by WEXO<sup>®</sup>  
SELECT/TAP

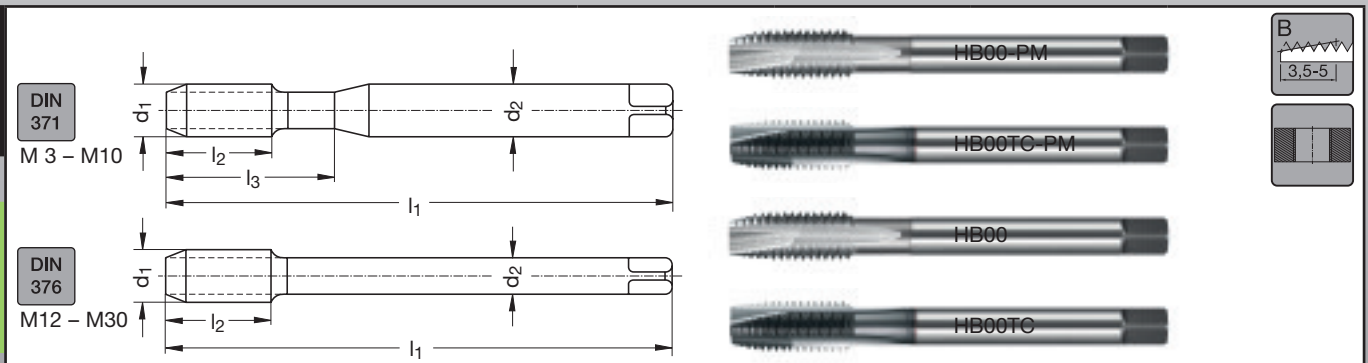

Katalog-Nr. <sup>W%</sup> Catalogue n <sup>o</sup> W%		Catalogue no. <sup>W%</sup> Nr. di catalogo <sup>W%</sup>							HB00-PM <sup>750</sup>		HB00TC-PM <sup>760</sup>		HB00 <sup>730</sup>		HB00TC <sup>740</sup>			
		d <sub>1</sub> [mm]	P [mm]	l <sub>1</sub> [mm]	l <sub>2</sub> [mm]	l <sub>3</sub> [mm]	d <sub>2</sub> [mm]	□ [mm]	z	∅ [mm]	Code	€	Code	€	Code	€	Code	€
M 3		0,5	56	9	18	3,5	2,7	3	2,5	610 000	23,00	614 000	30,50	600 760	12,75	603 760	20,00	
M 4		0,7	63	12	21	4,5	3,4	3	3,3	610 002	23,00	614 002	30,50	600 762	12,75	603 762	20,00	
M 5		0,8	70	13	25	6	4,9	3	4,2	610 003	24,00	614 003	32,25	600 763	13,50	603 763	20,25	
M 6		1	80	15	30	6	4,9	3	5	610 004	24,00	614 004	32,25	600 764	13,50	603 764	20,25	
M 8		1,25	90	18	35	8	6,2	3	6,8	610 006	29,50	614 006	39,25	600 766	16,50	603 766	26,25	
M 10		1,5	100	20	39	10	8	3	8,5	610 008	36,25	614 008	48,00	600 768	19,75	603 768	32,25	
M 12		1,75	110	23	-	9	7	3	10,2	610 010	43,75	614 010	59,00	600 770	26,00	603 770	40,75	
M 14		2	110	25	-	11	9	3	12					600 771	32,75	603 771	48,75	
M 16		2	110	25	-	12	9	3	14					600 772	39,25	603 772	59,00	
M 18		2,5	125	30	-	14	11	3	15,5					600 773	52,00	603 773	80,00	
M 20		2,5	140	30	-	16	12	3	17,5					600 774	62,50	603 774	91,00	
M 22		2,5	140	30	-	18	14,5	3	19,5					600 775	77,50	603 775	115,00	
M 24		3	160	36	-	18	14,5	4	21					600 776	84,50	603 776	122,00	
M 27		3	160	36	-	20	16	4	24					600 777	102,00	603 777	150,00	
M 30		3,5	180	40	-	22	18	4	26,5					600 778	142,00	603 778	185,00	

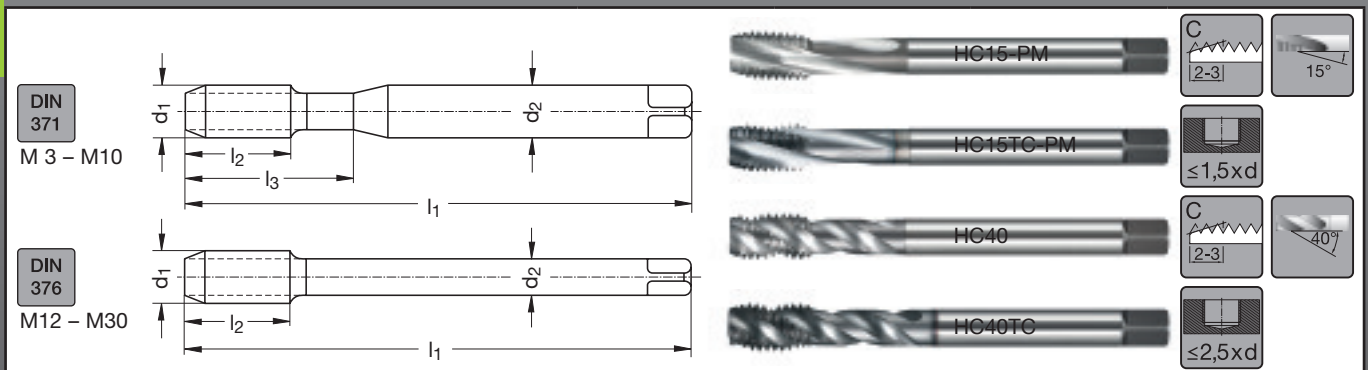

Katalog-Nr. <sup>W%</sup> Catalogue n <sup>o</sup> W%		Catalogue no. <sup>W%</sup> Nr. di catalogo <sup>W%</sup>							HC15-PM <sup>750</sup>		HC15TC-PM <sup>760</sup>		HC40 <sup>730</sup>		HC40TC <sup>740</sup>			
		d <sub>1</sub> [mm]	P [mm]	l <sub>1</sub> [mm]	l <sub>2</sub> [mm]	l <sub>3</sub> [mm]	d <sub>2</sub> [mm]	□ [mm]	z	∅ [mm]	Code	€	Code	€	Code	€	Code	€
M 3		0,5	56	5	18	3,5	2,7	3	2,5	610 020	25,25	614 020	33,50	600 780	13,75	603 780	20,25	
M 4		0,7	63	7	21	4,5	3,4	3	3,3	610 022	25,25	614 022	33,50	600 782	13,75	603 782	20,25	
M 5		0,8	70	8	25	6	4,9	3	4,2	610 023	27,00	614 023	35,00	600 783	14,00	603 783	20,50	
M 6		1	80	10	30	6	4,9	3	5	610 024	28,00	614 024	37,00	600 784	14,25	603 784	20,50	
M 8		1,25	90	13	35	8	6,2	3	6,8	610 026	30,50	614 026	40,75	600 786	17,25	603 786	26,25	
M 10		1,5	100	15	39	10	8	3	8,5	610 028	35,50	614 028	47,50	600 788	20,50	603 788	33,00	
M 12		1,75	110	18	-	9	7	3	10,2	610 030	45,50	614 030	60,50	600 790	28,00	603 790	42,00	
M 14		2	110	20	-	11	9	4	12					600 791	33,50	603 791	48,75	
M 16		2	110	20	-	12	9	4	14					600 792	42,00	603 792	60,00	
M 18		2,5	125	25	-	14	11	4	15,5					600 793	56,00	603 793	84,00	
M 20		2,5	140	25	-	16	12	4	17,5					600 794	66,00	603 794	95,00	
M 22		2,5	140	25	-	18	14,5	4	19,5					600 795	86,00	603 795	122,00	
M 24		3	160	30	-	18	14,5	4	21					600 796	88,00	603 796	127,00	
M 27		3	160	30	-	20	16	4	24					600 797	104,00	603 797	152,00	
M 30		3,5	180	35	-	22	18	5	26,5					600 798	145,00	603 798	188,00	



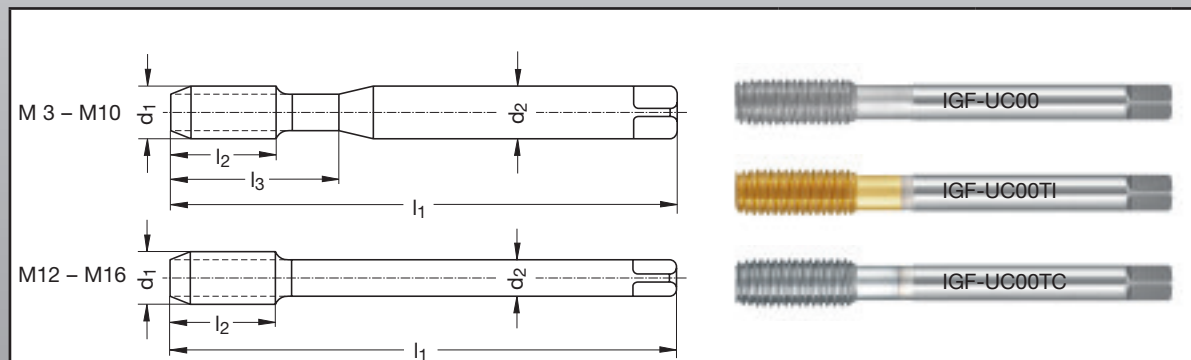

Katalog-Nr. <sup>W%</sup> Catalogue n° <sup>W%</sup>		Catalogue no. <sup>W%</sup> Nr. di catalogo <sup>W%</sup>							IGF-UC00 <sup>731</sup>		IGF-UC00TI <sup>741</sup>		IGF-UC00TC <sup>741</sup>	
d <sub>1</sub> [mm]	P [mm]	l <sub>1</sub> [mm]	l <sub>2</sub> [mm]	l <sub>3</sub> [mm]	d <sub>2</sub> [mm]	□ [mm]	z	∅ [mm]	Code	€	Code	€	Code	€
M 3	0,5	56	11	18	3,5	2,7	4	2,8	600 300	19,25	602 300	26,00	603 300	27,00
M 4	0,7	63	13	21	4,5	3,4	5	3,7	600 302	27,00	602 302	34,00	603 302	35,00
M 5	0,8	70	16	25	6	4,9	5	4,65	600 303	30,25	602 303	38,00	603 303	38,75
M 6	1	80	19	30	6	4,9	5	5,55	600 304	32,25	602 304	39,25	603 304	40,00
M 8	1,25	90	22	35	8	6,2	5	7,4	600 306	36,25	602 306	44,25	603 306	45,00
M 10	1,5	100	24	39	10	8	5	9,3	600 308	42,50	602 308	53,50	603 308	55,00
M 12	1,75	110	28	-	9	7	5	11,2	600 310	60,50	602 310	75,00	603 310	76,00
M 14	2	110	30	-	11	9	8	13	600 311	75,00	602 311	91,00	603 311	92,50
M 16	2	110	32	-	12	9	8	15	600 312	101,00	602 312	120,00	603 312	121,00

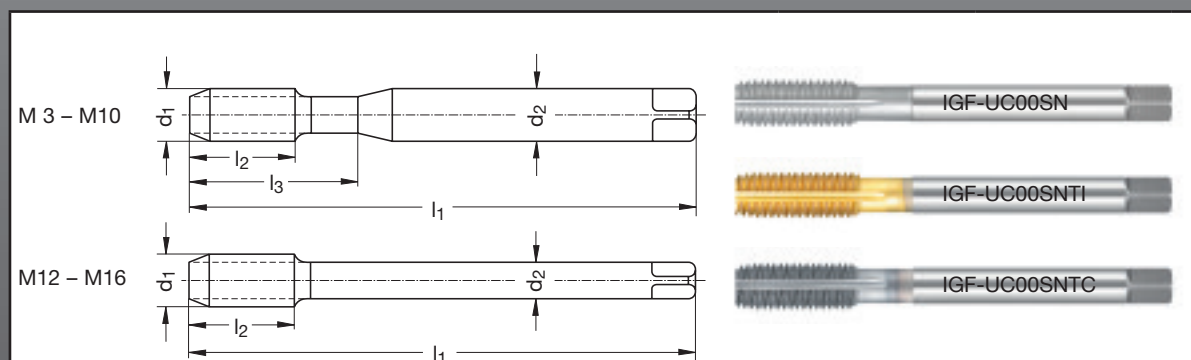

Katalog-Nr. <sup>W%</sup> Catalogue n° <sup>W%</sup>		Catalogue no. <sup>W%</sup> Nr. di catalogo <sup>W%</sup>							IGF-UC00SN <sup>731</sup>		IGF-UC00SNTI <sup>741</sup>		IGF-UC00SNTC <sup>741</sup>	
d <sub>1</sub> [mm]	P [mm]	l <sub>1</sub> [mm]	l <sub>2</sub> [mm]	l <sub>3</sub> [mm]	d <sub>2</sub> [mm]	□ [mm]	z	∅ [mm]	Code	€	Code	€	Code	€
M 3	0,5	56	11	18	3,5	2,7	4	2,8	600 280	20,00	602 280	27,25	603 280	28,00
M 4	0,7	63	13	21	4,5	3,4	5	3,7	600 282	28,00	602 282	35,50	603 282	37,00
M 5	0,8	70	16	25	6	4,9	5	4,65	600 283	32,25	602 283	39,25	603 283	40,00
M 6	1	80	19	30	6	4,9	5	5,55	600 284	34,00	602 284	41,25	603 284	42,00
M 8	1,25	90	22	35	8	6,2	5	7,4	600 286	37,50	602 286	45,50	603 286	47,00
M 10	1,5	100	24	39	10	8	5	9,3	600 288	44,25	602 288	57,00	603 288	58,00
M 12	1,75	110	28	-	9	7	5	11,2	600 290	63,50	602 290	77,50	603 290	78,50
M 14	2	110	30	-	11	9	8	13	600 291	78,50	602 291	95,00	603 291	96,00
M 16	2	110	32	-	12	9	8	15	600 292	107,00	602 292	126,00	603 292	127,00

M  
HSSE  
SELECT/TAP  
by WEXO<sup>®</sup>

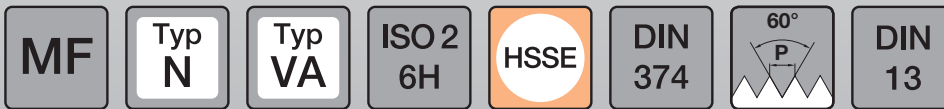

MF

HSSE

SELECT/TAP  
by WEXO<sup>®</sup>

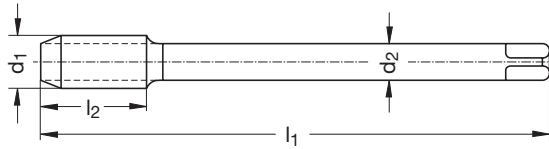

Katalog-Nr. <sup>W%</sup> Catalogue n <sup>o</sup> W%		Catalogue no. <sup>W%</sup> Nr. di catalogo <sup>W%</sup>							NB00-MF <sup>730</sup>		VAB00VP-MF <sup>730</sup>	
d <sub>1</sub> [mm]	P [mm]	l <sub>1</sub> [mm]	l <sub>2</sub> [mm]	d <sub>2</sub> [mm]	□ [mm]	z	∅ [mm]	Code	€	Code	€	
M 4	x 0,5	63	12	2,8	2,1	3	3,5	600 402	15,75			
M 5	x 0,5	70	13	3,5	2,7	3	4,5	600 403	16,50			
M 6	x 0,5	80	15	4,5	3,4	3	5,5	600 404	17,00			
M 6	x 0,75	80	15	4,5	3,4	3	5,2	600 405	16,50	601 061	19,50	
M 8	x 0,75	80	15	6	4,9	3	7,2	600 408	20,00			
M 8	x 1	90	18	6	4,9	3	7	600 409	18,00	601 063	21,00	
M 10	x 0,75	90	20	7	5,5	3	9,2	600 411	29,00			
M 10	x 1	90	20	7	5,5	3	9	600 412	21,00	601 064	23,75	
M 10	x 1,25	100	20	7	5,5	3	8,8	600 413	21,00			
M 12	x 1	100	21	9	7	3	11	600 415	24,25	601 065	29,75	
M 12	x 1,25	100	21	9	7	3	10,8	600 416	28,00			
M 12	x 1,5	100	21	9	7	3	10,5	600 417	23,00	601 066	27,25	
M 14	x 1,5	100	21	11	9	3	12,5	600 420	30,50			
M 16	x 1,5	100	21	12	9	3	14,5	600 424	37,00	601 068	42,50	
M 18	x 1,5	110	24	14	11	3	16,5	600 426	45,00			
M 20	x 1,5	125	24	16	12	3	18,5	600 429	52,00	601 070	67,00	

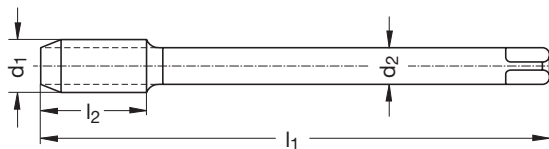

AG



Katalog-Nr. <sup>W%</sup> Catalogue n <sup>o</sup> W%		Catalogue no. <sup>W%</sup> Nr. di catalogo <sup>W%</sup>							NC40-MF <sup>730</sup>		VAC40VP-MF <sup>730</sup>	
d <sub>1</sub> [mm]	P [mm]	l <sub>1</sub> [mm]	l <sub>2</sub> [mm]	d <sub>2</sub> [mm]	□ [mm]	z	∅ [mm]	Code	€	Code	€	
M 4	x 0,5	63	7	2,8	2,1	3	3,5	600 502	17,50			
M 5	x 0,5	70	8	3,5	2,7	3	4,5	600 503	17,50			
M 6	x 0,5	80	10	4,5	3,4	3	5,5	600 504	17,50			
M 6	x 0,75	80	10	4,5	3,4	3	5,2	600 505	17,50	601 161	20,00	
M 8	x 0,75	80	10	6	4,9	3	7,2	600 508	20,25	601 162	30,50	
M 8	x 1	90	13	6	4,9	3	7	600 509	18,50	601 163	21,50	
M 10	x 1	90	12	7	5,5	3	9	600 512	21,25	601 164	24,00	
M 10	x 1,25	100	15	7	5,5	3	8,8	600 513	29,25			
M 12	x 1	100	14	9	7	3	11	600 515	25,75	601 165	29,75	
M 12	x 1,25	100	14	9	7	3	10,8	600 516	33,00			
M 12	x 1,5	100	14	9	7	3	10,5	600 517	23,75	601 166	28,50	
M 14	x 1,5	100	16	11	9	3	12,5	600 520	31,25	601 167	36,50	
M 16	x 1,5	100	16	12	9	4	14,5	600 524	38,00	601 168	44,25	
M 18	x 1,5	110	20	14	11	4	16,5	600 526	46,25			
M 20	x 1,5	125	20	16	12	4	18,5	600 529	53,50	601 170	69,00	

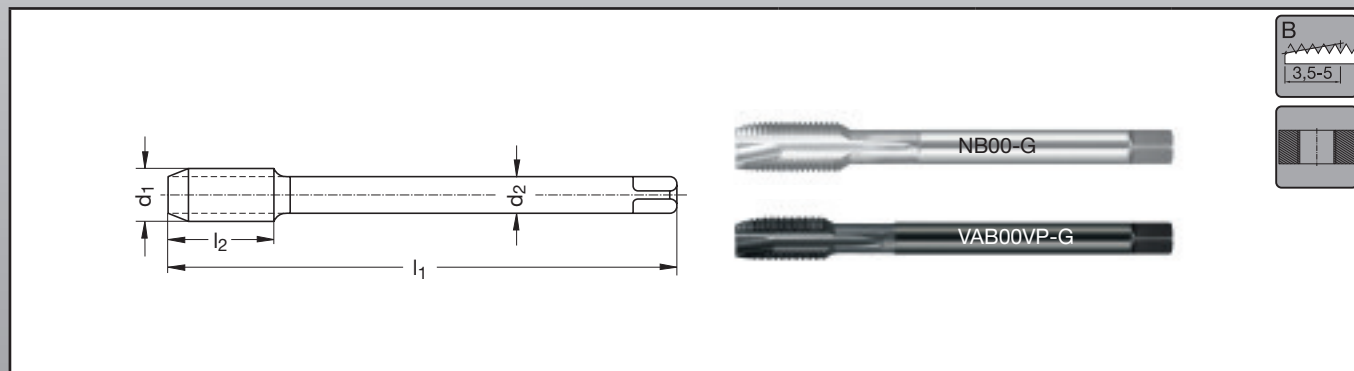
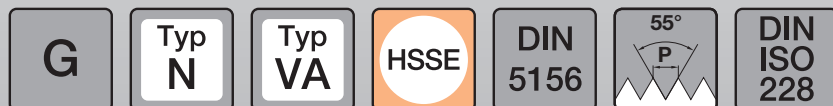

Katalog-Nr. W%		Catalogue no. W%							NB00-G <sup>730</sup>		VAB00VP-G <sup>730</sup>	
Catalogue n° W%		Nr. di catalogo W%							-		VP	
P	d <sub>1</sub>	l <sub>1</sub>	l <sub>2</sub>	d <sub>2</sub>	□	z	∅	Code	€	Code	€	
[Gg/1"]	[mm]	[mm]	[mm]	[mm]	[mm]		[mm]					
G 1/8	28	9,728	90	20	7	5,5	3	8,8	600 690	23,25	601 200	25,75
G 1/4	19	13,157	100	21	11	9	3	11,8	600 691	31,50	601 201	35,50
G 3/8	19	16,662	100	21	12	9	3	15,25	600 692	36,25	601 202	43,25
G 1/2	14	20,955	125	24	16	12	3	19	600 693	52,00	601 203	62,50
G 5/8	14	22,911	125	24	18	14,5	4	21			601 204	89,00
G 3/4	14	26,441	140	26	20	16	4	24,5	600 695	86,50	601 205	98,50
G 1	11	33,249	160	30	25	20	4	30,75	600 697	122,00	601 207	159,00
G 1/8	11	37,897	170	30	28	22	4	35,3			601 208	208,00
G 1/4	11	41,91	170	30	32	24	4	39,5			601 209	246,00
G 3/8	11	44,323	180	32	36	29	4	41,9			601 210	308,00
G 1/2	11	47,803	190	32	36	29	6	45,25			601 211	348,00
G 3/4	11	53,746	200	32	40	32	6	51,3			601 212	482,00
G 2	11	59,614	200	40	45	35	6	57			601 213	810,00

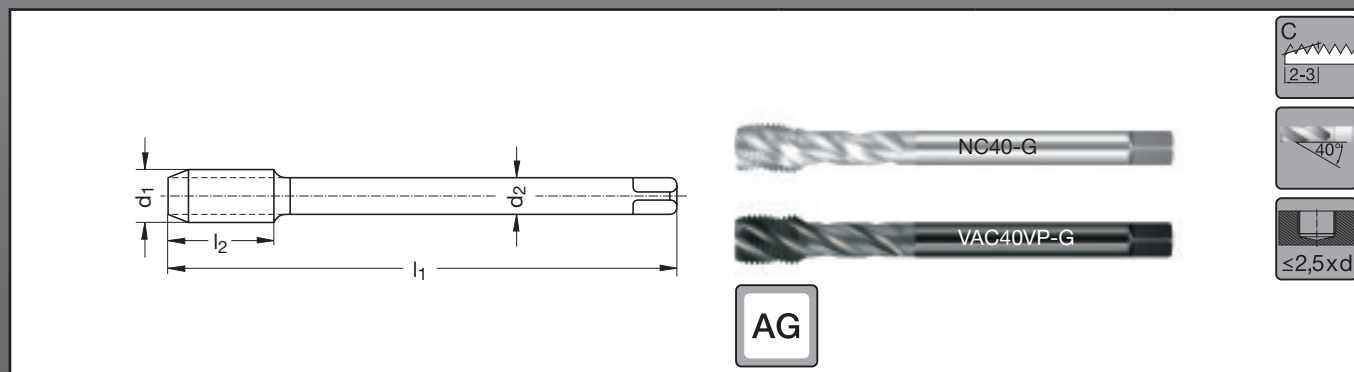

Katalog-Nr. W%		Catalogue no. W%							NC40-G <sup>730</sup>		VAC40VP-G <sup>730</sup>	
Catalogue n° W%		Nr. di catalogo W%							-		VP	
P	d <sub>1</sub>	l <sub>1</sub>	l <sub>2</sub>	d <sub>2</sub>	□	z	∅	Code	€	Code	€	
[Gg/1"]	[mm]	[mm]	[mm]	[mm]	[mm]		[mm]					
G 1/8	28	9,728	90	12	7	5,5	3	8,8	600 710	24,25	601 300	29,50
G 1/4	19	13,157	100	16	11	9	3	11,8	600 711	32,25	601 301	39,25
G 3/8	19	16,662	100	16	12	9	3	15,25	600 712	37,50	601 302	53,50
G 1/2	14	20,955	125	20	16	12	4	19	600 713	53,50	601 303	77,50
G 5/8	14	22,911	125	20	18	14,5	4	21			601 304	114,00
G 3/4	14	26,441	140	22	20	16	4	24,5	600 715	100,00	601 305	142,00
G 1	11	33,249	160	30	25	20	4	30,75	600 717	150,00	601 307	218,00
G 1/8	11	37,897	170	30	28	22	5	35,3			601 308	296,00
G 1/4	11	41,91	170	30	32	24	5	39,5			601 309	320,00
G 3/8	11	44,323	180	32	36	29	5	41,9			601 310	398,00
G 1/2	11	47,803	190	32	36	29	5	45,25			601 311	438,00
G 3/4	11	53,746	200	32	40	32	5	51,3			601 312	550,00
G 2	11	59,614	200	40	45	35	5	57			601 313	890,00

G

HSSE

SELECT/TAP  
by WEXO<sup>®</sup>



UNC

HSSE

SELECT/TAP  
by WEXO<sup>®</sup>

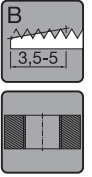
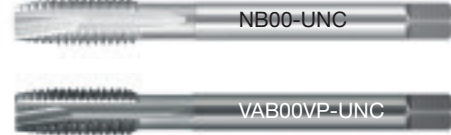
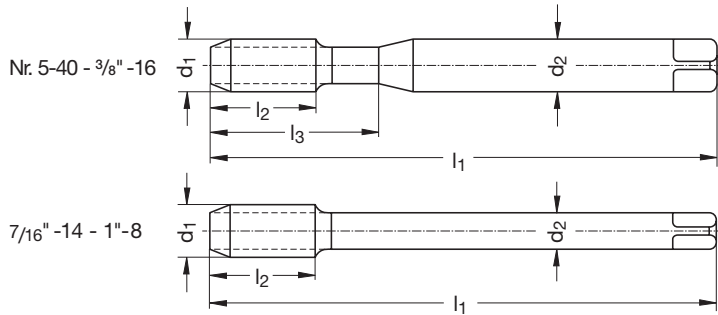

Katalog-Nr. <sup>W%</sup> Catalogue n <sup>o</sup> W%	Catalogue no. <sup>W%</sup> Nr. di catalogo <sup>W%</sup>	NB00-UNC <sup>730</sup>		VAB00VP-UNC <sup>730</sup>							
		Code	€	Code	€						
P [Gg/1"]	d <sub>1</sub> [mm]	l <sub>1</sub> [mm]	l <sub>2</sub> [mm]	d <sub>2</sub> [mm]	□ [mm]	z	∅ [mm]	Code	€	Code	€
UNC # 5 - 40	3,175	56	9	6	2,7	-	2,65			601 604	27,75
UNC # 6 - 32	3,505	56	11	6	3	-	2,85			601 605	22,50
UNC # 8 - 32	4,166	63	12	4,5	3,4	3	3,5	600 606	18,00	601 606	23,25
UNC # 10 - 24	4,826	70	13	6	4,9	3	3,9	600 607	18,50	601 607	24,00
UNC # 12 - 24	5,486	80	15	6	4,9	3	4,5	600 608	19,50	601 608	25,00
UNC 1/4" - 20	6,35	80	15	7	5,5	3	5,2	600 609	21,25	601 609	27,75
UNC 5/16" - 18	7,938	90	18	8	6,2	3	6,6	600 610	22,00	601 610	29,00
UNC 3/8" - 16	9,525	90	20	9	7	3	8	600 611	26,25	601 611	34,50
UNC 7/16" - 14	11,113	100	20	8	6,2	3	9,4	600 620	27,00	601 620	35,00
UNC 1/2" - 13	12,7	110	23	9	7	3	10,75	600 621	34,00	601 621	44,25
UNC 9/16" - 12	14,288	110	25	11	9	3	12,25	600 622	51,00	601 622	67,00
UNC 5/8" - 11	15,875	110	25	12	9	3	13,5	600 623	44,25	601 623	58,00
UNC 3/4" - 10	19,05	125	30	14	11	3	16,5	600 624	50,00	601 624	68,00
UNC 7/8" - 9	22,225	140	30	18	14,5	3	19,5	600 625	62,50	601 625	80,50
UNC 1" - 8	25,400	160	36	18	14,5	3	22,25	600 626	86,50	601 626	120,00

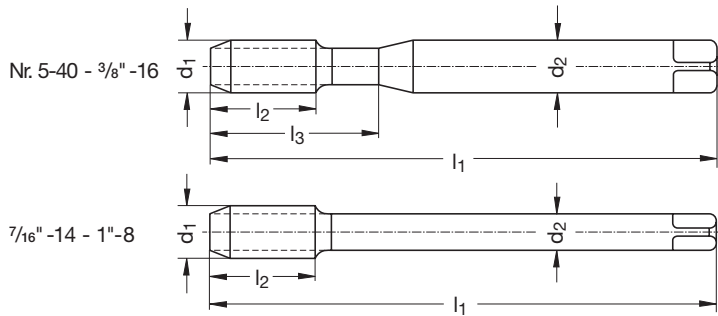

Katalog-Nr. <sup>W%</sup> Catalogue n <sup>o</sup> W%	Catalogue no. <sup>W%</sup> Nr. di catalogo <sup>W%</sup>	NC40-UNC <sup>730</sup>		VAC40VP-UNC <sup>730</sup>							
		Code	€	Code	€						
P [Gg/1"]	d <sub>1</sub> [mm]	l <sub>1</sub> [mm]	l <sub>2</sub> [mm]	d <sub>2</sub> [mm]	□ [mm]	z	∅ [mm]	Code	€	Code	€
UNC # 5 - 40	3,175	56	5	6	2,7	-	2,65			601 633	28,00
UNC # 6 - 32	3,505	56	7	6	3	-	2,85			601 634	23,00
UNC # 8 - 32	4,166	63	7	4,5	3,4	3	3,5	600 635	18,25	601 635	23,75
UNC # 10 - 24	4,826	70	8	6	4,9	3	3,9	600 636	19,75	601 636	25,25
UNC # 12 - 24	5,486	80	10	6	4,9	3	4,5	600 637	21,75	601 637	28,25
UNC 1/4" - 20	6,35	80	10	7	5,5	3	5,2	600 638	21,75	601 638	28,25
UNC 5/16" - 18	7,938	90	13	8	6,2	3	6,6	600 639	23,00	601 639	30,00
UNC 3/8" - 16	9,525	90	15	9	7	3	8	600 640	27,50	601 640	36,00
UNC 7/16" - 14	11,113	100	18	8	6,2	3	9,4	600 650	27,50	601 650	36,00
UNC 1/2" - 13	12,7	110	20	9	7	3	10,75	600 651	36,25	601 651	47,00
UNC 9/16" - 12	14,288	110	20	11	9	3	12,25	600 652	52,50	601 652	69,00
UNC 5/8" - 11	15,875	110	20	12	9	3	13,5	600 653	45,00	601 653	59,00
UNC 3/4" - 10	19,05	125	25	14	11	4	16,5	600 654	50,50	601 654	69,50
UNC 7/8" - 9	22,225	140	25	18	14,5	4	19,5	600 655	63,50	601 655	82,50
UNC 1" - 8	25,400	160	30	18	14,5	4	22,25	600 656	87,50	601 656	122,00



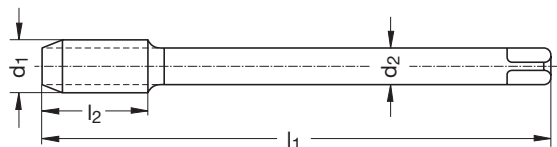
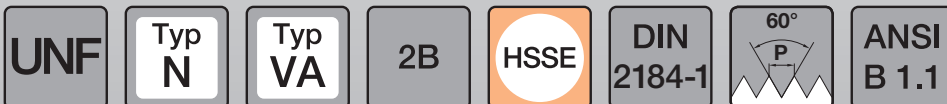

UNF

HSSE

Katalog-Nr. <sup>W%</sup> Catalogue n° <sup>W%</sup>	Catalogue no. <sup>W%</sup> Nr. di catalogo <sup>W%</sup>	NB00-UNF <sup>730</sup>		VAB00VP-UNF <sup>730</sup>					
		Code	€	Code	€				
P [Gg/1"]	d <sub>1</sub> [mm]	l <sub>1</sub> [mm]	l <sub>2</sub> [mm]	d <sub>2</sub> [mm]	□	z	∅ [mm]	Code	€
UNF # 5 - 44	3,175	56	9	2,2	-	3	2,7		
UNF # 6 - 40	3,505	56	11	2,5	2,1	3	2,95		
UNF # 8 - 36	4,166	63	12	2,8	2,1	3	3,5		
UNF # 10 - 32	4,826	70	13	3,5	2,7	3	4,1	600 670	26,25
UNF # 12 - 28	5,486	80	15	4	3	3	4,65	600 672	30,50
UNF 1/4" - 28	6,35	80	15	4,5	3,4	3	5,5	600 673	29,25
UNF 5/16" - 24	7,938	90	18	6	4,9	3	6,9	600 674	31,50
UNF 3/8" - 24	9,525	90	20	7	5,5	3	8,5	600 675	33,50
UNF 7/16" - 20	11,113	100	20	8	6,2	3	9,9	600 676	41,25
UNF 1/2" - 20	12,7	100	21	9	7	3	11,5	600 677	43,25
UNF 9/16" - 18	14,28	100	21	11	9	3	12,9		
UNF 5/8" - 18	15,875	100	21	12	9	3	14,5	600 679	56,00
UNF 3/4" - 16	19,05	110	24	14	11	3	17,5	600 680	71,00
UNF 7/8" - 14	22,225	125	24	18	14,5	3	20,5	600 681	91,00
UNF 1" - 12	25,4	140	26	18	14,5	3	23,25	600 682	132,00

SELECT/TAP  
by WEXO<sup>®</sup>

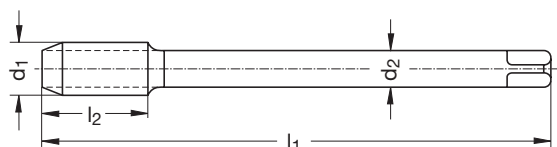

Katalog-Nr. <sup>W%</sup> Catalogue n° <sup>W%</sup>	Catalogue no. <sup>W%</sup> Nr. di catalogo <sup>W%</sup>	NC40-UNF <sup>730</sup>		VAC40VP-UNF <sup>730</sup>					
		Code	€	Code	€				
P [Gg/1"]	d <sub>1</sub> [mm]	l <sub>1</sub> [mm]	l <sub>2</sub> [mm]	d <sub>2</sub> [mm]	□	z	∅ [mm]	Code	€
UNF # 5 - 44	3,175	56	5	2,2	-	3	2,7		
UNF # 6 - 40	3,505	56	7	2,5	2,1	3	2,95		
UNF # 8 - 36	4,166	63	7	2,8	2,1	3	3,5		
UNF # 10 - 32	4,826	70	8	3,5	2,7	3	4,1	600 853	27,50
UNF # 12 - 28	5,486	80	10	4	3	3	4,65	600 854	32,25
UNF 1/4" - 28	6,35	80	10	4,5	2,7	3	5,5	600 855	30,25
UNF 5/16" - 24	7,938	90	13	6	4,9	3	6,9	600 856	33,50
UNF 3/8" - 24	9,525	90	15	7	5,5	3	8,5	600 857	36,25
UNF 7/16" - 20	11,113	100	15	8	6,2	3	9,9	600 858	43,75
UNF 1/2" - 20	12,7	100	14	9	7	3	11,5	600 859	45,00
UNF 9/16" - 18	14,28	100	16	11	9	3	12,9		
UNF 5/8" - 18	15,875	100	16	12	9	3	14,5	600 861	59,50
UNF 3/4" - 16	19,05	110	20	14	11	3	17,5	600 862	75,00
UNF 7/8" - 14	22,225	125	20	18	14,5	3	20,5	600 863	95,00
UNF 1" - 12	25,4	140	22	18	14,5	3	23,25	600 864	140,00

M	Typ N	ISO 2 6H	HSSE	DIN 371	DIN 376	60° P	DIN 13	B 3,5-5	
Abmessung Dimension Dimension Dimensione	Code	W% 730							
M 3 - M12	600 994	142,00 €	1 x M 3 - M 4 - M 5 - M 6 - M 8 - M10 - M12 1 x Ø 2,5 - 3,3 - 4,2 - 5,0 - 6,8 - 8,5 - 10,2 DIN 338, HSS, Typ N.						

M	Typ VA	ISO 2 6H	HSSE	DIN 371	DIN 376	60° P	DIN 13	B 3,5-5	
Abmessung Dimension Dimension Dimensione	Code	W% 730							
M 3 - M12	600 995	148,00 €	1 x M 3 - M 4 - M 5 - M 6 - M 8 - M10 - M12 1 x Ø 2,5 - 3,3 - 4,2 - 5,0 - 6,8 - 8,5 - 10,2 DIN 338, HSSE, Typ VA.						

by WEXO<sup>®</sup>  
**SELECT/TAP**

M	Typ N	ISO 2 6H	HSSE	DIN 371	DIN 376	60° P	DIN 13	C 2-3		40°		≤2,5xd
Abmessung Dimension Dimension Dimensione	Code	W% 730										
M 3 - M12	600 996	145,00 €	1 x M 3 - M 4 - M 5 - M 6 - M 8 - M10 - M12 1 x Ø 2,5 - 3,3 - 4,2 - 5,0 - 6,8 - 8,5 - 10,2 DIN 338, HSS, Typ N.									

M	Typ VA	ISO 2 6H	HSSE	DIN 371	DIN 376	60° P	DIN 13	AG	C 2-3	40°		≤2,5xd
Abmessung Dimension Dimension Dimensione	Code	W% 730										
M 3 - M12	600 997	152,00 €	1 x M 3 - M 4 - M 5 - M 6 - M 8 - M10 - M12 1 x Ø 2,5 - 3,3 - 4,2 - 5,0 - 6,8 - 8,5 - 10,2 DIN 338, HSSE, Typ VA.									



**SELECT/DRILL**  
by WEXO<sup>®</sup>

**SELECT/DRILL**  
by WEXO<sup>®</sup>

**NC-Anbohrer / NC-Spotting drill / NC-Foret à pointer / NC-Punte da centro**

<b>NCA90-HM / 15 / NCA90TA-HM / 15</b>						<b>25</b>
		Typ <b>UNI</b>		DIN 6535 <b>HA</b> < Ø 6,0 mm	DIN 6535 <b>HB</b> ≥ Ø 6,0 mm	
<b>NCA142-HM / 15 / NCA142TA-HM / 15</b>						<b>25</b>
		Typ <b>UNI</b>		DIN 6535 <b>HA</b> < Ø 6,0 mm	DIN 6535 <b>HB</b> ≥ Ø 6,0 mm	

**VHM Hochleistungsbohrer / Solid Carbide High Performance Twist Drill /  
Foret en carbure monobloc à haute performance / Punte ad alta prestazione in MDI**

<b>S3DTA-HM</b>						<b>26</b>	
	DIN 6537K	Typ <b>UNI</b>	3 x d			DIN 6535- <b>HA</b> DIN 6535- <b>HB</b> DIN 6535- <b>HE</b>	
<b>S3DIKTA-HM</b>						<b>27</b>	
	DIN 6537K	Typ <b>UNI</b>	3 x d IKZ			DIN 6535- <b>HA</b> DIN 6535- <b>HB</b> DIN 6535- <b>HE</b>	
<b>S5DTA-HM</b>						<b>28</b>	
	DIN 6537L	Typ <b>UNI</b>	5 x d			DIN 6535- <b>HA</b> DIN 6535- <b>HB</b> DIN 6535- <b>HE</b>	
<b>S5DIKTA-HM</b>						<b>29</b>	
	DIN 6537L	Typ <b>UNI</b>	5 x d IKZ			DIN 6535- <b>HA</b> DIN 6535- <b>HB</b> DIN 6535- <b>HE</b>	
<b>S8DIKTA-HM</b>						<b>30</b>	
		Typ <b>UNI</b>	8 x d IKZ			DIN 6535- <b>HA</b> DIN 6535- <b>HB</b> DIN 6535- <b>HE</b>	
<b>S12DIKTA-HM</b>						<b>30</b>	
		Typ <b>UNI</b>	12 x d IKZ			DIN 6535- <b>HA</b> DIN 6535- <b>HB</b> DIN 6535- <b>HE</b>	
<b>VAS3DIKTA-HM</b>						<b>31</b>	
	DIN 6537K	Typ <b>VA</b>	3 x d IKZ			DIN 6535- <b>HA</b> DIN 6535- <b>HB</b> DIN 6535- <b>HE</b>	
<b>VAS5DIKTA-HM</b>						<b>32</b>	
	DIN 6537L	Typ <b>VA</b>	5 x d IKZ			DIN 6535- <b>HA</b> DIN 6535- <b>HB</b> DIN 6535- <b>HE</b>	
<b>VAS8DIKTA-HM</b>						<b>34</b>	
		Typ <b>VA</b>	8 x d IKZ			DIN 6535- <b>HA</b> DIN 6535- <b>HB</b> DIN 6535- <b>HE</b>	
<b>VAS12DIKTA-HM</b>						<b>35</b>	
		Typ <b>VA</b>	12 x d IKZ			DIN 6535- <b>HA</b> DIN 6535- <b>HB</b> DIN 6535- <b>HE</b>	

by WEXO<sup>®</sup>  
**SELECT / DRILL**



$d_1 = h_6$   
 $d_2 = h_6$

Katalog-Nr. <sup>W%</sup> Catalogue no. <sup>W%</sup> Catalogue n° <sup>W%</sup> Nr. di catalogo <sup>W%</sup>				<b>NCA90-HM<sup>870</sup></b>		Katalog-Nr. <sup>W%</sup> Catalogue no. <sup>W%</sup> Catalogue n° <sup>W%</sup> Nr. di catalogo <sup>W%</sup>				<b>NCA90TA-HM<sup>880</sup></b>	
										TiAlN	
$d_1$ [mm]	$l_2$ [mm]	$l_1$ [mm]	$d_2$ [mm]	Code 	€	$d_1$ [mm]	$l_2$ [mm]	$l_1$ [mm]	$d_2$ [mm]	Code 	€
3,0	8	35	3,0	680 001	7,90	3,0	8	35	3,0	685 001	12,75
4,0	10	40	4,0	680 002	9,65	4,0	10	40	4,0	685 002	14,75
6,0	16	50	6,0	680 004	22,75	6,0	16	50	6,0	685 004	27,50
8,0	23	60	8,0	680 005	29,50	8,0	23	60	8,0	685 005	35,50
10,0	24	70	10,0	680 006	43,25	10,0	24	70	10,0	685 006	50,50
12,0	25	70	12,0	680 007	58,50	12,0	25	70	12,0	685 007	67,00
16,0	30	80	16,0	680 008	107,00	16,0	30	80	16,0	685 008	118,00
20,0	35	100	20,0	680 009	183,00	20,0	35	100	20,0	685 009	204,00

VHM



$d_1 = h_6$   
 $d_2 = h_6$

Katalog-Nr. <sup>W%</sup> Catalogue no. <sup>W%</sup> Catalogue n° <sup>W%</sup> Nr. di catalogo <sup>W%</sup>				<b>NCA142-HM<sup>870</sup></b>		Katalog-Nr. <sup>W%</sup> Catalogue no. <sup>W%</sup> Catalogue n° <sup>W%</sup> Nr. di catalogo <sup>W%</sup>				<b>NCA142TA-HM<sup>880</sup></b>	
										TiAlN	
$d_1$ [mm]	$l_2$ [mm]	$l_1$ [mm]	$d_2$ [mm]	Code 	€	$d_1$ [mm]	$l_2$ [mm]	$l_1$ [mm]	$d_2$ [mm]	Code 	€
3,0	8	35	3,0	680 011	7,90	3,0	8	35	3,0	685 011	12,75
4,0	10	40	4,0	680 012	9,65	4,0	10	40	4,0	685 012	14,75
6,0	16	50	6,0	680 014	22,75	6,0	16	50	6,0	685 014	27,50
8,0	23	60	8,0	680 015	29,50	8,0	23	60	8,0	685 015	35,50
10,0	24	70	10,0	680 016	43,25	10,0	24	70	10,0	685 016	50,50
12,0	25	70	12,0	680 017	58,50	12,0	25	70	12,0	685 017	67,00
16,0	30	80	16,0	680 018	107,00	16,0	30	80	16,0	685 018	118,00
20,0	35	100	20,0	680 019	183,00	20,0	35	100	20,0	685 019	204,00

SELECT / DRILL  
by WEXO<sup>®</sup>



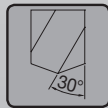
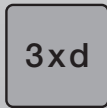

VHM

d<sub>1</sub> = h7  
d<sub>2</sub> = h6

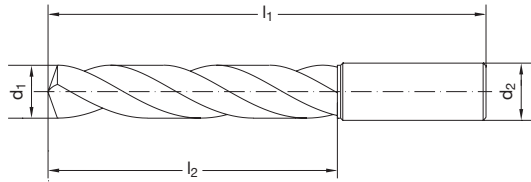

Katalog-Nr. <sup>W%</sup> Catalogue no. <sup>W%</sup> Catalogue n° <sup>W%</sup> Nr. di catalogo <sup>W%</sup>				S3DTA-HM <sup>880</sup>			Katalog-Nr. <sup>W%</sup> Catalogue no. <sup>W%</sup> Catalogue n° <sup>W%</sup> Nr. di catalogo <sup>W%</sup>				S3DTA-HM <sup>880</sup>		
				TiAIN							TiAIN		
d <sub>1</sub> [mm]	l <sub>2</sub> [mm]	l <sub>1</sub> [mm]	d <sub>2</sub> [mm]	Code	€	d <sub>1</sub> [mm]	l <sub>2</sub> [mm]	l <sub>1</sub> [mm]	d <sub>2</sub> [mm]	Code	€		
2,0	20	55	4,0	685 020 HA	32,25	7,7	41	79	8,0	685 077 H?	33,50		
2,1	20	55	4,0	685 021 HA	32,25	7,8	41	79	8,0	685 078 H?	33,50		
2,2	20	55	4,0	685 022 HA	32,25	7,9	41	79	8,0	685 079 H?	33,50		
2,3	20	55	4,0	685 023 HA	32,25	8,0	41	79	8,0	685 080 H?	33,50		
2,4	20	55	4,0	685 024 HA	32,25	8,1	47	89	10,0	685 081 H?	38,75		
2,5	20	55	4,0	685 025 HA	32,25	8,2	47	89	10,0	685 082 H?	38,75		
2,6	20	55	4,0	685 026 HA	32,25	8,3	47	89	10,0	685 083 H?	38,75		
2,7	20	55	4,0	685 027 HA	32,25	8,4	47	89	10,0	685 084 H?	38,75		
2,8	20	55	4,0	685 028 HA	32,25	8,5	47	89	10,0	685 085 H?	38,75		
2,9	20	55	4,0	685 029 HA	32,25	8,6	47	89	10,0	685 086 H?	38,75		
3,0	20	62	6,0	685 030 H?	32,25	8,7	47	89	10,0	685 087 H?	38,75		
3,1	20	62	6,0	685 031 H?	32,25	8,8	47	89	10,0	685 088 H?	38,75		
3,2	20	62	6,0	685 032 H?	32,25	8,9	47	89	10,0	685 089 H?	38,75		
3,3	20	62	6,0	685 033 H?	32,25	9,0	47	89	10,0	685 090 H?	38,75		
3,4	20	62	6,0	685 034 H?	32,25	9,1	47	89	10,0	685 091 H?	38,75		
3,5	20	62	6,0	685 035 H?	32,25	9,2	47	89	10,0	685 092 H?	38,75		
3,6	20	62	6,0	685 036 H?	32,25	9,3	47	89	10,0	685 093 H?	38,75		
3,7	20	62	6,0	685 037 H?	32,25	9,4	47	89	10,0	685 094 H?	38,75		
3,8	24	66	6,0	685 038 H?	32,25	9,5	47	89	10,0	685 095 H?	38,75		
3,9	24	66	6,0	685 039 H?	32,25	9,6	47	89	10,0	685 096 H?	38,75		
4,0	24	66	6,0	685 040 H?	32,25	9,7	47	89	10,0	685 097 H?	38,75		
4,1	24	66	6,0	685 041 H?	32,25	9,8	47	89	10,0	685 098 H?	38,75		
4,2	24	66	6,0	685 042 H?	32,25	9,9	47	89	10,0	685 099 H?	38,75		
4,3	24	66	6,0	685 043 H?	32,25	10,0	47	89	10,0	685 100 H?	38,75		
4,4	24	66	6,0	685 044 H?	32,25	10,1	55	102	12,0	685 101 H?	55,50		
4,5	24	66	6,0	685 045 H?	32,25	10,2	55	102	12,0	685 102 H?	55,50		
4,6	24	66	6,0	685 046 H?	32,25	10,3	55	102	12,0	685 103 H?	55,50		
4,7	24	66	6,0	685 047 H?	32,25	10,4	55	102	12,0	685 104 H?	55,50		
4,8	28	66	6,0	685 048 H?	32,25	10,5	55	102	12,0	685 105 H?	55,50		
4,9	28	66	6,0	685 049 H?	32,25	10,6	55	102	12,0	685 106 H?	55,50		
5,0	28	66	6,0	685 050 H?	32,25	10,7	55	102	12,0	685 107 H?	55,50		
5,1	28	66	6,0	685 051 H?	32,25	10,8	55	102	12,0	685 108 H?	55,50		
5,2	28	66	6,0	685 052 H?	32,25	10,9	55	102	12,0	685 109 H?	55,50		
5,3	28	66	6,0	685 053 H?	32,25	11,0	55	102	12,0	685 110 H?	55,50		
5,4	28	66	6,0	685 054 H?	32,25	11,2	55	102	12,0	685 112 H?	55,50		
5,5	28	66	6,0	685 055 H?	32,25	11,5	55	102	12,0	685 115 H?	55,50		
5,6	28	66	6,0	685 056 H?	32,25	11,8	55	102	12,0	685 118 H?	55,50		
5,7	28	66	6,0	685 057 H?	32,25	12,0	55	102	12,0	685 120 H?	55,50		
5,8	28	66	6,0	685 058 H?	32,25	12,2	60	107	14,0	685 122 H?	74,50		
5,9	28	66	6,0	685 059 H?	32,25	12,5	60	107	14,0	685 125 H?	74,50		
6,0	28	66	6,0	685 060 H?	32,25	12,8	60	107	14,0	685 128 H?	74,50		
6,1	34	79	8,0	685 061 H?	33,50	13,0	60	107	14,0	685 130 H?	74,50		
6,2	34	79	8,0	685 062 H?	33,50	13,5	60	107	14,0	685 135 H?	74,50		
6,3	34	79	8,0	685 063 H?	33,50	13,8	60	107	14,0	685 138 H?	74,50		
6,4	34	79	8,0	685 064 H?	33,50	14,0	60	107	14,0	685 140 H?	74,50		
6,5	34	79	8,0	685 065 H?	33,50	14,5	65	115	16,0	685 145 H?	96,50		
6,6	34	79	8,0	685 066 H?	33,50	15,0	65	115	16,0	685 150 H?	96,50		
6,7	34	79	8,0	685 067 H?	33,50	15,5	65	115	16,0	685 155 H?	96,50		
6,8	34	79	8,0	685 068 H?	33,50	16,0	65	115	16,0	685 160 H?	96,50		
6,9	34	79	8,0	685 069 H?	33,50	16,5	73	123	18,0	685 165 H?	151,00		
7,0	34	79	8,0	685 070 H?	33,50	17,0	73	123	18,0	685 170 H?	151,00		
7,1	41	79	8,0	685 071 H?	33,50	17,5	73	123	18,0	685 175 H?	151,00		
7,2	41	79	8,0	685 072 H?	33,50	18,0	73	123	18,0	685 180 H?	151,00		
7,3	41	79	8,0	685 073 H?	33,50	18,5	79	131	20,0	685 185 H?	177,00		
7,4	41	79	8,0	685 074 H?	33,50	19,0	79	131	20,0	685 190 H?	177,00		
7,5	41	79	8,0	685 075 H?	33,50	19,5	79	131	20,0	685 195 H?	177,00		
7,6	41	79	8,0	685 076 H?	33,50	20,0	79	131	20,0	685 200 H?	177,00		

Andere Abmessungen auf Anfrage · Other sizes upon request · Autres dimensions sur demande · Altre dimensioni a richiesta

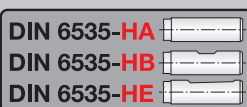
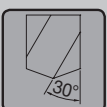

d<sub>1</sub> = h7  
d<sub>2</sub> = h6

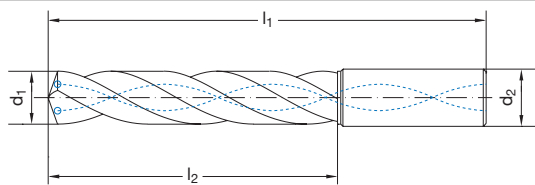

VHM

Katalog-Nr. <sup>W%</sup> Catalogue no. <sup>W%</sup> Catalogue n° <sup>W%</sup> Nr. di catalogo <sup>W%</sup>				S3DIKTA-HM <sup>880</sup>		Katalog-Nr. <sup>W%</sup> Catalogue no. <sup>W%</sup> Catalogue n° <sup>W%</sup> Nr. di catalogo <sup>W%</sup>				S3DIKTA-HM <sup>880</sup>	
				TiAlN						TiAlN	
d <sub>1</sub> [mm]	l <sub>2</sub> [mm]	l <sub>1</sub> [mm]	d <sub>2</sub> [mm]	Code	€	d <sub>1</sub> [mm]	l <sub>2</sub> [mm]	l <sub>1</sub> [mm]	d <sub>2</sub> [mm]	Code	€
3,0	20	62	6,0	685 230 H?	43,25	8,2	47	89	10,0	685 282 H?	71,00
3,1	20	62	6,0	685 231 H?	43,25	8,3	47	89	10,0	685 283 H?	71,00
3,2	20	62	6,0	685 232 H?	43,25	8,4	47	89	10,0	685 284 H?	71,00
3,3	20	62	6,0	685 233 H?	43,25	8,5	47	89	10,0	685 285 H?	71,00
3,4	20	62	6,0	685 234 H?	43,25	8,6	47	89	10,0	685 286 H?	71,00
3,5	20	62	6,0	685 235 H?	43,25	8,7	47	89	10,0	685 287 H?	71,00
3,6	20	62	6,0	685 236 H?	43,25	8,8	47	89	10,0	685 288 H?	71,00
3,7	20	62	6,0	685 237 H?	43,25	8,9	47	89	10,0	685 289 H?	71,00
3,8	24	66	6,0	685 238 H?	43,25	9,0	47	89	10,0	685 290 H?	71,00
3,9	24	66	6,0	685 239 H?	43,25	9,1	47	89	10,0	685 291 H?	71,00
4,0	24	66	6,0	685 240 H?	43,25	9,2	47	89	10,0	685 292 H?	71,00
4,1	24	66	6,0	685 241 H?	43,25	9,3	47	89	10,0	685 293 H?	71,00
4,2	24	66	6,0	685 242 H?	43,25	9,4	47	89	10,0	685 294 H?	71,00
4,3	24	66	6,0	685 243 H?	43,25	9,5	47	89	10,0	685 295 H?	71,00
4,4	24	66	6,0	685 244 H?	43,25	9,6	47	89	10,0	685 296 H?	71,00
4,5	24	66	6,0	685 245 H?	43,25	9,7	47	89	10,0	685 297 H?	71,00
4,6	24	66	6,0	685 246 H?	43,25	9,8	47	89	10,0	685 298 H?	71,00
4,7	24	66	6,0	685 247 H?	43,25	9,9	47	89	10,0	685 299 H?	71,00
4,8	28	66	6,0	685 248 H?	43,25	10,0	47	89	10,0	685 300 H?	71,00
4,9	28	66	6,0	685 249 H?	43,25	10,1	55	102	12,0	685 301 H?	97,50
5,0	28	66	6,0	685 250 H?	43,25	10,2	55	102	12,0	685 302 H?	97,50
5,1	28	66	6,0	685 251 H?	43,25	10,3	55	102	12,0	685 303 H?	97,50
5,2	28	66	6,0	685 252 H?	43,25	10,4	55	102	12,0	685 304 H?	97,50
5,3	28	66	6,0	685 253 H?	43,25	10,5	55	102	12,0	685 305 H?	97,50
5,4	28	66	6,0	685 254 H?	43,25	10,6	55	102	12,0	685 306 H?	97,50
5,5	28	66	6,0	685 255 H?	43,25	10,7	55	102	12,0	685 307 H?	97,50
5,6	28	66	6,0	685 256 H?	43,25	10,8	55	102	12,0	685 308 H?	97,50
5,7	28	66	6,0	685 257 H?	43,25	10,9	55	102	12,0	685 309 H?	97,50
5,8	28	66	6,0	685 258 H?	43,25	11,0	55	102	12,0	685 310 H?	97,50
5,9	28	66	6,0	685 259 H?	43,25	11,2	55	102	12,0	685 312 H?	97,50
6,0	28	66	6,0	685 260 H?	43,25	11,5	55	102	12,0	685 315 H?	97,50
6,1	34	79	8,0	685 261 H?	57,00	11,8	55	102	12,0	685 318 H?	97,50
6,2	34	79	8,0	685 262 H?	57,00	12,0	55	102	12,0	685 320 H?	97,50
6,3	34	79	8,0	685 263 H?	57,00	12,2	60	107	14,0	685 322 H?	129,00
6,4	34	79	8,0	685 264 H?	57,00	12,5	60	107	14,0	685 325 H?	129,00
6,5	34	79	8,0	685 265 H?	57,00	12,8	60	107	14,0	685 328 H?	129,00
6,6	34	79	8,0	685 266 H?	57,00	13,0	60	107	14,0	685 330 H?	129,00
6,7	34	79	8,0	685 267 H?	57,00	13,5	60	107	14,0	685 335 H?	129,00
6,8	34	79	8,0	685 268 H?	57,00	13,8	60	107	14,0	685 338 H?	129,00
6,9	34	79	8,0	685 269 H?	57,00	14,0	60	107	14,0	685 340 H?	129,00
7,0	34	79	8,0	685 270 H?	57,00	14,5	65	115	16,0	685 345 H?	156,00
7,1	41	79	8,0	685 271 H?	57,00	15,0	65	115	16,0	685 350 H?	156,00
7,2	41	79	8,0	685 272 H?	57,00	15,5	65	115	16,0	685 355 H?	156,00
7,3	41	79	8,0	685 273 H?	57,00	16,0	65	115	16,0	685 360 H?	156,00
7,4	41	79	8,0	685 274 H?	57,00	16,5	73	123	18,0	685 365 H?	236,00
7,5	41	79	8,0	685 275 H?	57,00	17,0	73	123	18,0	685 370 H?	236,00
7,6	41	79	8,0	685 276 H?	57,00	17,5	73	123	18,0	685 375 H?	236,00
7,7	41	79	8,0	685 277 H?	57,00	18,0	73	123	18,0	685 380 H?	236,00
7,8	41	79	8,0	685 278 H?	57,00	18,5	79	131	20,0	685 385 H?	270,00
7,9	41	79	8,0	685 279 H?	57,00	19,0	79	131	20,0	685 390 H?	270,00
8,0	41	79	8,0	685 280 H?	57,00	19,5	79	131	20,0	685 395 H?	270,00
8,1	47	89	10,0	685 281 H?	71,00	20,0	79	131	20,0	685 400 H?	270,00

SELECT / DRILL  
by WEXO®

Andere Abmessungen auf Anfrage · Other sizes upon request · Autres dimensions sur demande · Altre dimensioni a richiesta

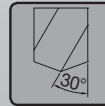
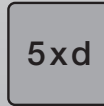

VHM

d<sub>1</sub> = m7  
d<sub>2</sub> = h6

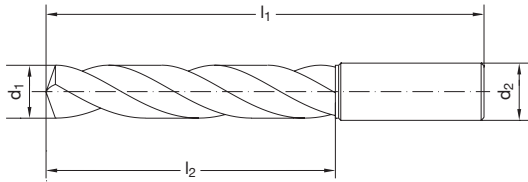

Katalog-Nr. <sup>W%</sup> Catalogue no. <sup>W%</sup> Catalogue n° <sup>W%</sup> Nr. di catalogo <sup>W%</sup>				S5DTA-HM <sup>880</sup>				Katalog-Nr. <sup>W%</sup> Catalogue no. <sup>W%</sup> Catalogue n° <sup>W%</sup> Nr. di catalogo <sup>W%</sup>				S5DTA-HM <sup>880</sup>					
				TiAIN								TiAIN					
d <sub>1</sub> [mm]	l <sub>2</sub> [mm]	l <sub>1</sub> [mm]	d <sub>2</sub> [mm]	Code	€	d <sub>1</sub> [mm]	l <sub>2</sub> [mm]	l <sub>1</sub> [mm]	d <sub>2</sub> [mm]	Code	€	d <sub>1</sub> [mm]	l <sub>2</sub> [mm]	l <sub>1</sub> [mm]	d <sub>2</sub> [mm]	Code	€
3,0	28	66	6,0	686 430 H?	37,75	8,7	61	103	10,0	686 487 H?	56,50	8,7	61	103	10,0	686 487 H?	56,50
3,1	28	66	6,0	686 431 H?	37,75	8,8	61	103	10,0	686 488 H?	56,50	8,8	61	103	10,0	686 488 H?	56,50
3,2	28	66	6,0	686 432 H?	37,75	8,9	61	103	10,0	686 489 H?	56,50	8,9	61	103	10,0	686 489 H?	56,50
3,3	28	66	6,0	686 433 H?	37,75	9,0	61	103	10,0	686 490 H?	56,50	9,0	61	103	10,0	686 490 H?	56,50
3,4	28	66	6,0	686 434 H?	37,75	9,1	61	103	10,0	686 491 H?	56,50	9,1	61	103	10,0	686 491 H?	56,50
3,5	28	66	6,0	686 435 H?	37,75	9,2	61	103	10,0	686 492 H?	56,50	9,2	61	103	10,0	686 492 H?	56,50
3,6	28	66	6,0	686 436 H?	37,75	9,3	61	103	10,0	686 493 H?	56,50	9,3	61	103	10,0	686 493 H?	56,50
3,7	28	66	6,0	686 437 H?	37,75	9,4	61	103	10,0	686 494 H?	56,50	9,4	61	103	10,0	686 494 H?	56,50
3,8	36	74	6,0	686 438 H?	37,75	9,5	61	103	10,0	686 495 H?	56,50	9,5	61	103	10,0	686 495 H?	56,50
3,9	36	74	6,0	686 439 H?	37,75	9,6	61	103	10,0	686 496 H?	56,50	9,6	61	103	10,0	686 496 H?	56,50
4,0	36	74	6,0	686 440 H?	37,75	9,7	61	103	10,0	686 497 H?	56,50	9,7	61	103	10,0	686 497 H?	56,50
4,1	36	74	6,0	686 441 H?	37,75	9,8	61	103	10,0	686 498 H?	56,50	9,8	61	103	10,0	686 498 H?	56,50
4,2	36	74	6,0	686 442 H?	37,75	9,9	61	103	10,0	686 499 H?	56,50	9,9	61	103	10,0	686 499 H?	56,50
4,3	36	74	6,0	686 443 H?	37,75	10,0	61	103	10,0	686 500 H?	56,50	10,0	61	103	10,0	686 500 H?	56,50
4,4	36	74	6,0	686 444 H?	37,75	10,1	71	118	12,0	686 501 H?	74,50	10,1	71	118	12,0	686 501 H?	74,50
4,5	36	74	6,0	686 445 H?	37,75	10,2	71	118	12,0	686 502 H?	74,50	10,2	71	118	12,0	686 502 H?	74,50
4,6	36	74	6,0	686 446 H?	37,75	10,3	71	118	12,0	686 503 H?	74,50	10,3	71	118	12,0	686 503 H?	74,50
4,7	36	74	6,0	686 447 H?	37,75	10,4	71	118	12,0	686 504 H?	74,50	10,4	71	118	12,0	686 504 H?	74,50
4,8	44	82	6,0	686 448 H?	37,75	10,5	71	118	12,0	686 505 H?	74,50	10,5	71	118	12,0	686 505 H?	74,50
4,9	44	82	6,0	686 449 H?	37,75	10,6	71	118	12,0	686 506 H?	74,50	10,6	71	118	12,0	686 506 H?	74,50
5,0	44	82	6,0	686 450 H?	37,75	10,7	71	118	12,0	686 507 H?	74,50	10,7	71	118	12,0	686 507 H?	74,50
5,1	44	82	6,0	686 451 H?	37,75	10,8	71	118	12,0	686 508 H?	74,50	10,8	71	118	12,0	686 508 H?	74,50
5,2	44	82	6,0	686 452 H?	37,75	10,9	71	118	12,0	686 509 H?	74,50	10,9	71	118	12,0	686 509 H?	74,50
5,3	44	82	6,0	686 453 H?	37,75	11,0	71	118	12,0	686 510 H?	74,50	11,0	71	118	12,0	686 510 H?	74,50
5,4	44	82	6,0	686 454 H?	37,75	11,5	71	118	12,0	686 515 H?	74,50	11,5	71	118	12,0	686 515 H?	74,50
5,5	44	82	6,0	686 455 H?	37,75	11,8	71	118	12,0	686 518 H?	74,50	11,8	71	118	12,0	686 518 H?	74,50
5,6	44	82	6,0	686 456 H?	37,75	12,0	71	118	12,0	686 520 H?	74,50	12,0	71	118	12,0	686 520 H?	74,50
5,7	44	82	6,0	686 457 H?	37,75	12,5	77	124	14,0	686 525 H?	112,00	12,5	77	124	14,0	686 525 H?	112,00
5,8	44	82	6,0	686 458 H?	37,75	13,0	77	124	14,0	686 530 H?	112,00	13,0	77	124	14,0	686 530 H?	112,00
5,9	44	82	6,0	686 459 H?	37,75	13,5	77	124	14,0	686 535 H?	112,00	13,5	77	124	14,0	686 535 H?	112,00
6,0	44	82	6,0	686 460 H?	37,75	14,0	77	124	14,0	686 540 H?	112,00	14,0	77	124	14,0	686 540 H?	112,00
6,1	53	91	8,0	686 461 H?	39,00	14,5	83	133	16,0	686 545 H?	144,00	14,5	83	133	16,0	686 545 H?	144,00
6,2	53	91	8,0	686 462 H?	39,00	15,0	83	133	16,0	686 550 H?	144,00	15,0	83	133	16,0	686 550 H?	144,00
6,3	53	91	8,0	686 463 H?	39,00	15,5	83	133	16,0	686 555 H?	144,00	15,5	83	133	16,0	686 555 H?	144,00
6,4	53	91	8,0	686 464 H?	39,00	16,0	83	133	16,0	686 560 H?	144,00	16,0	83	133	16,0	686 560 H?	144,00
6,5	53	91	8,0	686 465 H?	39,00	16,5	93	143	18,0	686 565 H?	208,00	16,5	93	143	18,0	686 565 H?	208,00
6,6	53	91	8,0	686 466 H?	39,00	17,0	93	143	18,0	686 570 H?	208,00	17,0	93	143	18,0	686 570 H?	208,00
6,7	53	91	8,0	686 467 H?	39,00	17,5	93	143	18,0	686 575 H?	208,00	17,5	93	143	18,0	686 575 H?	208,00
6,8	53	91	8,0	686 468 H?	39,00	18,0	93	143	18,0	686 580 H?	208,00	18,0	93	143	18,0	686 580 H?	208,00
6,9	53	91	8,0	686 469 H?	39,00	18,5	101	153	20,0	686 585 H?	296,00	18,5	101	153	20,0	686 585 H?	296,00
7,0	53	91	8,0	686 470 H?	39,00	19,0	101	153	20,0	686 590 H?	296,00	19,0	101	153	20,0	686 590 H?	296,00
7,1	53	91	8,0	686 471 H?	39,00	19,5	101	153	20,0	686 595 H?	296,00	19,5	101	153	20,0	686 595 H?	296,00
7,2	53	91	8,0	686 472 H?	39,00	20,0	101	153	20,0	686 600 H?	296,00	20,0	101	153	20,0	686 600 H?	296,00
7,3	53	91	8,0	686 473 H?	39,00												
7,4	53	91	8,0	686 474 H?	39,00												
7,5	53	91	8,0	686 475 H?	39,00												
7,6	53	91	8,0	686 476 H?	39,00												
7,7	53	91	8,0	686 477 H?	39,00												
7,8	53	91	8,0	686 478 H?	39,00												
7,9	53	91	8,0	686 479 H?	39,00												
8,0	53	91	8,0	686 480 H?	39,00												
8,1	61	103	10,0	686 481 H?	56,50												
8,2	61	103	10,0	686 482 H?	56,50												
8,3	61	103	10,0	686 483 H?	56,50												
8,4	61	103	10,0	686 484 H?	56,50												
8,5	61	103	10,0	686 485 H?	56,50												
8,6	61	103	10,0	686 486 H?	56,50												

Andere Abmessungen auf Anfrage · Other sizes upon request · Autres dimensions sur demande · Altre dimensioni a richiesta

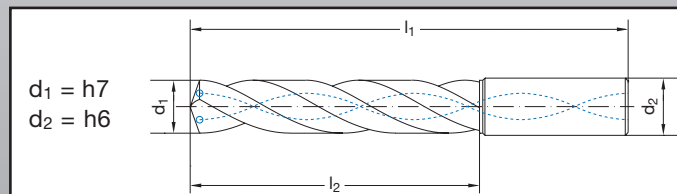
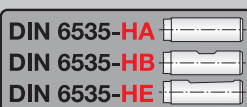
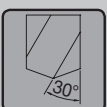

VHM

Katalog-Nr. <sup>W%</sup> Catalogue no. <sup>W%</sup> Catalogue n° <sup>W%</sup> Nr. di catalogo <sup>W%</sup>				S5DIKTA-HM <sup>880</sup>			Katalog-Nr. <sup>W%</sup> Catalogue no. <sup>W%</sup> Catalogue n° <sup>W%</sup> Nr. di catalogo <sup>W%</sup>				S5DIKTA-HM <sup>880</sup>		
				TiAlN							TiAlN		
d <sub>1</sub> [mm]	l <sub>2</sub> [mm]	l <sub>1</sub> [mm]	d <sub>2</sub> [mm]	Code	€	d <sub>1</sub> [mm]	l <sub>2</sub> [mm]	l <sub>1</sub> [mm]	d <sub>2</sub> [mm]	Code	€		
2,8	21	57	4,0	685 428 HA	55,50	8,3	61	103	10,0	685 483 H?	73,00		
2,85	21	57	4,0	685 603 HA	55,50	8,4	61	103	10,0	685 484 H?	73,00		
3,0	28	66	6,0	685 430 H?	55,50	8,5	61	103	10,0	685 485 H?	73,00		
3,1	28	66	6,0	685 431 H?	55,50	8,6	61	103	10,0	685 486 H?	73,00		
3,2	28	66	6,0	685 432 H?	55,50	8,7	61	103	10,0	685 487 H?	73,00		
3,3	28	66	6,0	685 433 H?	55,50	8,8	61	103	10,0	685 488 H?	73,00		
3,4	28	66	6,0	685 434 H?	55,50	8,9	61	103	10,0	685 489 H?	73,00		
3,5	28	66	6,0	685 435 H?	55,50	9,0	61	103	10,0	685 490 H?	73,00		
3,6	28	66	6,0	685 436 H?	55,50	9,1	61	103	10,0	685 491 H?	73,00		
3,7	28	66	6,0	685 437 H?	55,50	9,2	61	103	10,0	685 492 H?	73,00		
3,8	36	74	6,0	685 438 H?	55,50	9,3	61	103	10,0	685 493 H?	73,00		
3,9	36	74	6,0	685 439 H?	55,50	9,4	61	103	10,0	685 494 H?	73,00		
4,0	36	74	6,0	685 440 H?	55,50	9,5	61	103	10,0	685 495 H?	73,00		
4,1	36	74	6,0	685 441 H?	55,50	9,55	61	103	10,0	685 608 H?	73,00		
4,2	36	74	6,0	685 442 H?	55,50	9,6	61	103	10,0	685 496 H?	73,00		
4,3	36	74	6,0	685 443 H?	55,50	9,7	61	103	10,0	685 497 H?	73,00		
4,4	36	74	6,0	685 444 H?	55,50	9,8	61	103	10,0	685 498 H?	73,00		
4,5	36	74	6,0	685 445 H?	55,50	9,9	61	103	10,0	685 499 H?	73,00		
4,6	36	74	6,0	685 446 H?	55,50	10,0	61	103	10,0	685 500 H?	73,00		
4,65	36	74	6,0	685 604 H?	55,50	10,1	71	118	12,0	685 501 H?	101,00		
4,7	36	74	6,0	685 447 H?	55,50	10,2	71	118	12,0	685 502 H?	101,00		
4,8	44	82	6,0	685 448 H?	55,50	10,3	71	118	12,0	685 503 H?	101,00		
4,9	44	82	6,0	685 449 H?	55,50	10,4	71	118	12,0	685 504 H?	101,00		
5,0	44	82	6,0	685 450 H?	55,50	10,5	71	118	12,0	685 505 H?	101,00		
5,1	44	82	6,0	685 451 H?	55,50	10,6	71	118	12,0	685 506 H?	101,00		
5,2	44	82	6,0	685 452 H?	55,50	10,7	71	118	12,0	685 507 H?	101,00		
5,3	44	82	6,0	685 453 H?	55,50	10,8	71	118	12,0	685 508 H?	101,00		
5,4	44	82	6,0	685 454 H?	55,50	10,9	71	118	12,0	685 509 H?	101,00		
5,5	44	82	6,0	685 455 H?	55,50	11,0	71	118	12,0	685 510 H?	101,00		
5,55	44	82	6,0	685 605 H?	55,50	11,2	71	118	12,0	685 512 H?	101,00		
5,6	44	82	6,0	685 456 H?	55,50	11,3	71	118	12,0	685 513 H?	101,00		
5,65	44	82	6,0	685 606 H?	55,50	11,5	71	118	12,0	685 515 H?	101,00		
5,7	44	82	6,0	685 457 H?	55,50	11,8	71	118	12,0	685 518 H?	101,00		
5,8	44	82	6,0	685 458 H?	55,50	12,0	71	118	12,0	685 520 H?	101,00		
5,9	44	82	6,0	685 459 H?	55,50	12,2	77	124	14,0	685 522 H?	139,00		
6,0	44	82	6,0	685 460 H?	55,50	12,5	77	124	14,0	685 525 H?	139,00		
6,1	53	91	8,0	685 461 H?	62,00	12,8	77	124	14,0	685 528 H?	139,00		
6,2	53	91	8,0	685 462 H?	62,00	13,0	77	124	14,0	685 530 H?	139,00		
6,3	53	91	8,0	685 463 H?	62,00	13,3	77	124	14,0	685 533 H?	139,00		
6,4	53	91	8,0	685 464 H?	62,00	13,5	77	124	14,0	685 535 H?	139,00		
6,5	53	91	8,0	685 465 H?	62,00	13,8	77	124	14,0	685 538 H?	139,00		
6,6	53	91	8,0	685 466 H?	62,00	14,0	77	124	14,0	685 540 H?	139,00		
6,7	53	91	8,0	685 467 H?	62,00	14,5	83	133	16,0	685 545 H?	166,00		
6,8	53	91	8,0	685 468 H?	62,00	15,0	83	133	16,0	685 550 H?	166,00		
6,9	53	91	8,0	685 469 H?	62,00	15,3	83	133	16,0	685 553 H?	166,00		
7,0	53	91	8,0	685 470 H?	62,00	15,5	83	133	16,0	685 555 H?	166,00		
7,1	53	91	8,0	685 471 H?	62,00	16,0	83	133	16,0	685 560 H?	166,00		
7,2	53	91	8,0	685 472 H?	62,00	16,5	93	143	18,0	685 565 H?	268,00		
7,3	53	91	8,0	685 473 H?	62,00	17,0	93	143	18,0	685 570 H?	268,00		
7,4	53	91	8,0	685 474 H?	62,00	17,5	93	143	18,0	685 575 H?	268,00		
7,5	53	91	8,0	685 475 H?	62,00	18,0	93	143	18,0	685 580 H?	268,00		
7,55	53	91	8,0	685 607 H?	62,00	18,5	101	153	20,0	685 585 H?	292,00		
7,6	53	91	8,0	685 476 H?	62,00	19,0	101	153	20,0	685 590 H?	292,00		
7,7	53	91	8,0	685 477 H?	62,00	19,5	101	153	20,0	685 595 H?	292,00		
7,8	53	91	8,0	685 478 H?	62,00	20,0	101	153	20,0	685 600 H?	292,00		
7,9	53	91	8,0	685 479 H?	62,00								
8,0	53	91	8,0	685 480 H?	62,00								
8,1	61	103	10,0	685 481 H?	73,00								
8,2	61	103	10,0	685 482 H?	73,00								

SELECT / DRILL  
by WEXO®



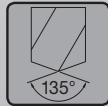
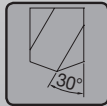

VHM

$d_1 = h_7$   
 $d_2 = h_6$

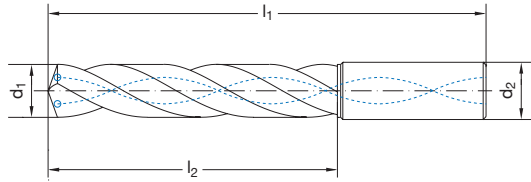

8xD  
IKZ

Katalog-Nr. <sup>W%</sup> Catalogue no. <sup>W%</sup> Catalogue n° <sup>W%</sup> Nr. di catalogo <sup>W%</sup>				S8DIKTA-HM <sup>880</sup>			Katalog-Nr. <sup>W%</sup> Catalogue no. <sup>W%</sup> Catalogue n° <sup>W%</sup> Nr. di catalogo <sup>W%</sup>				S8DIKTA-HM <sup>880</sup>		
				TiAIN							TiAIN		
d <sub>1</sub> [mm]	l <sub>2</sub> [mm]	l <sub>1</sub> [mm]	d <sub>2</sub> [mm]	Code	€	d <sub>1</sub> [mm]	l <sub>2</sub> [mm]	l <sub>1</sub> [mm]	d <sub>2</sub> [mm]	Code	€		
3,0	34	72	6,0	685 620 H?	114,00	11,0	114	162	12,0	685 700 H?	240,00		
3,3	34	72	6,0	685 623 H?	114,00	11,5	114	162	12,0	685 705 H?	240,00		
3,5	34	72	6,0	685 625 H?	114,00	12,0	114	162	12,0	685 710 H?	240,00		
4,0	43	81	6,0	685 630 H?	114,00	12,5	133	178	14,0	685 715 H?	344,00		
4,2	43	81	6,0	685 632 H?	114,00	12,7	133	178	14,0	685 717 H?	344,00		
4,5	43	81	6,0	685 635 H?	114,00	13,0	133	178	14,0	685 720 H?	344,00		
5,0	57	95	6,0	685 640 H?	114,00	13,5	133	178	14,0	685 725 H?	344,00		
5,5	57	95	6,0	685 645 H?	114,00	14,0	133	178	14,0	685 730 H?	344,00		
6,0	57	95	6,0	685 650 H?	114,00	14,5	152	203	16,0	685 735 H?	460,00		
6,5	76	114	8,0	685 655 H?	142,00	15,0	152	203	16,0	685 740 H?	460,00		
6,8	76	114	8,0	685 658 H?	142,00	15,5	152	203	16,0	685 745 H?	460,00		
7,0	76	114	8,0	685 660 H?	142,00	16,0	152	203	16,0	685 750 H?	460,00		
7,5	76	114	8,0	685 665 H?	142,00	16,5	171	222	18,0	685 755 H?	560,00		
7,8	76	114	8,0	685 668 H?	142,00	17,0	171	222	18,0	685 760 H?	560,00		
8,0	76	114	8,0	685 670 H?	142,00	17,5	171	222	18,0	685 765 H?	560,00		
8,5	95	142	10,0	685 675 H?	179,00	18,0	171	222	18,0	685 770 H?	560,00		
9,0	95	142	10,0	685 680 H?	179,00	18,5	190	243	20,0	685 775 H?	670,00		
9,5	95	142	10,0	685 685 H?	179,00	19,0	190	243	20,0	685 780 H?	670,00		
10,0	95	142	10,0	685 690 H?	179,00	19,5	190	243	20,0	685 785 H?	670,00		
10,2	114	162	12,0	685 692 H?	240,00	20,0	190	243	20,0	685 790 H?	670,00		
10,5	114	162	12,0	685 695 H?	240,00								

Andere Abmessungen auf Anfrage · Other sizes upon request · Autres dimensions sur demande · Altre dimensioni a richiesta

by WEXO<sup>®</sup>  
SELECT / DRILL

$d_1 = h_7$   
 $d_2 = h_6$

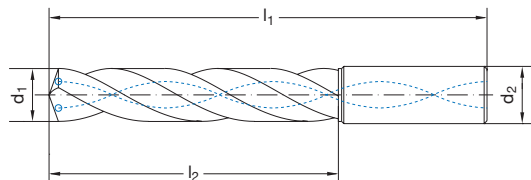

12xD  
IKZ

Katalog-Nr. <sup>W%</sup> Catalogue no. <sup>W%</sup> Catalogue n° <sup>W%</sup> Nr. di catalogo <sup>W%</sup>				S12DIKTA-HM <sup>880</sup>			Katalog-Nr. <sup>W%</sup> Catalogue no. <sup>W%</sup> Catalogue n° <sup>W%</sup> Nr. di catalogo <sup>W%</sup>				S12DIKTA-HM <sup>880</sup>		
				TiAIN							TiAIN		
d <sub>1</sub> [mm]	l <sub>2</sub> [mm]	l <sub>1</sub> [mm]	d <sub>2</sub> [mm]	Code	€	d <sub>1</sub> [mm]	l <sub>2</sub> [mm]	l <sub>1</sub> [mm]	d <sub>2</sub> [mm]	Code	€		
3,0	54	92	6,0	685 800 H?	150,00	11,0	156	204	12,0	685 880 H?	344,00		
3,3	54	92	6,0	685 803 H?	150,00	11,5	156	204	12,0	685 885 H?	344,00		
3,5	54	92	6,0	685 805 H?	150,00	12,0	156	204	12,0	685 890 H?	344,00		
4,0	64	102	6,0	685 810 H?	150,00	12,5	182	230	14,0	685 895 H?	442,00		
4,2	64	102	6,0	685 812 H?	150,00	12,7	182	230	14,0	685 897 H?	442,00		
4,5	64	102	6,0	685 815 H?	150,00	13,0	182	230	14,0	685 900 H?	442,00		
5,0	78	116	6,0	685 820 H?	150,00	13,5	182	230	14,0	685 905 H?	442,00		
5,5	78	116	6,0	685 825 H?	150,00	14,0	182	230	14,0	685 910 H?	442,00		
6,0	78	116	6,0	685 830 H?	150,00	14,5	208	260	16,0	685 915 H?	590,00		
6,5	108	146	8,0	685 835 H?	183,00	15,0	208	260	16,0	685 920 H?	590,00		
6,8	108	146	8,0	685 838 H?	183,00	15,5	208	260	16,0	685 925 H?	590,00		
7,0	108	146	8,0	685 840 H?	183,00	16,0	208	260	16,0	685 930 H?	590,00		
7,5	108	146	8,0	685 845 H?	183,00	16,5	234	285	18,0	685 935 H?	640,00		
7,8	108	146	8,0	685 848 H?	183,00	17,0	234	285	18,0	685 940 H?	640,00		
8,0	108	146	8,0	685 850 H?	183,00	17,5	234	285	18,0	685 945 H?	640,00		
8,5	120	162	10,0	685 855 H?	246,00	18,0	234	285	18,0	685 950 H?	640,00		
9,0	120	162	10,0	685 860 H?	246,00	18,5	258	310	20,0	685 955 H?	780,00		
9,5	120	162	10,0	685 865 H?	246,00	19,0	258	310	20,0	685 960 H?	780,00		
10,0	120	162	10,0	685 870 H?	246,00	19,5	258	310	20,0	685 965 H?	780,00		
10,2	156	204	12,0	685 872 H?	344,00	20,0	258	310	20,0	685 970 H?	780,00		

Andere Abmessungen auf Anfrage · Other sizes upon request · Autres dimensions sur demande · Altre dimensioni a richiesta





DIN 6537K

Typ VA

3xd IKZ

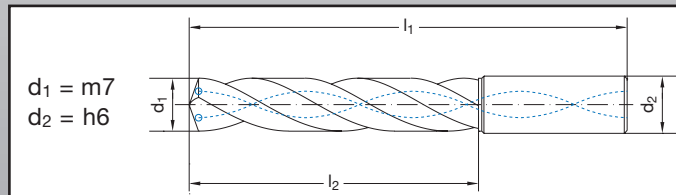
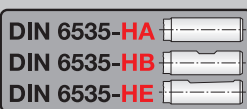
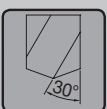

VHM

Katalog-Nr. <sup>W%</sup> Catalogue no. <sup>W%</sup> Catalogue n° <sup>W%</sup> Nr. di catalogo <sup>W%</sup>				VAS3DIKTA-HM <sup>880</sup>			Katalog-Nr. <sup>W%</sup> Catalogue no. <sup>W%</sup> Catalogue n° <sup>W%</sup> Nr. di catalogo <sup>W%</sup>				VAS3DIKTA-HM <sup>880</sup>		
				TiAIN							TiAIN		
d <sub>1</sub> [mm]	l <sub>2</sub> [mm]	l <sub>1</sub> [mm]	d <sub>2</sub> [mm]	Code	€	d <sub>1</sub> [mm]	l <sub>2</sub> [mm]	l <sub>1</sub> [mm]	d <sub>2</sub> [mm]	Code	€		
2,0	20	55	4	687 220 HA	49,25	8,1	47	89	10	687 281 H?	81,00		
2,1	20	55	4	687 221 HA	49,25	8,2	47	89	10	687 282 H?	81,00		
2,2	20	55	4	687 222 HA	49,25	8,3	47	89	10	687 283 H?	81,00		
2,3	20	55	4	687 223 HA	49,25	8,4	47	89	10	687 284 H?	81,00		
2,4	20	55	4	687 224 HA	49,25	8,5	47	89	10	687 285 H?	81,00		
2,5	20	55	4	687 225 HA	49,25	8,6	47	89	10	687 286 H?	81,00		
2,6	20	55	4	687 226 HA	49,25	8,7	47	89	10	687 287 H?	81,00		
2,7	20	55	4	687 227 HA	49,25	8,8	47	89	10	687 288 H?	81,00		
2,8	20	55	4	687 228 HA	49,25	8,9	47	89	10	687 289 H?	81,00		
2,9	20	55	4	687 229 HA	49,25	9,0	47	89	10	687 290 H?	81,00		
3,0	20	62	6	687 230 H?	49,25	9,1	47	89	10	687 291 H?	81,00		
3,1	20	62	6	687 231 H?	49,25	9,2	47	89	10	687 292 H?	81,00		
3,2	20	62	6	687 232 H?	49,25	9,3	47	89	10	687 293 H?	81,00		
3,3	20	62	6	687 233 H?	49,25	9,4	47	89	10	687 294 H?	81,00		
3,4	20	62	6	687 234 H?	49,25	9,5	47	89	10	687 295 H?	81,00		
3,5	20	62	6	687 235 H?	49,25	9,6	47	89	10	687 296 H?	81,00		
3,6	20	62	6	687 236 H?	49,25	9,7	47	89	10	687 297 H?	81,00		
3,7	20	62	6	687 237 H?	49,25	9,8	47	89	10	687 298 H?	81,00		
3,8	24	66	6	687 238 H?	49,25	9,9	47	89	10	687 299 H?	81,00		
3,9	24	66	6	687 239 H?	49,25	10,0	47	89	10	687 300 H?	81,00		
4,0	24	66	6	687 240 H?	49,25	10,1	55	102	12	687 301 H?	113,00		
4,1	24	66	6	687 241 H?	49,25	10,2	55	102	12	687 302 H?	113,00		
4,2	24	66	6	687 242 H?	49,25	10,3	55	102	12	687 303 H?	113,00		
4,3	24	66	6	687 243 H?	49,25	10,4	55	102	12	687 304 H?	113,00		
4,4	24	66	6	687 244 H?	49,25	10,5	55	102	12	687 305 H?	113,00		
4,5	24	66	6	687 245 H?	49,25	10,6	55	102	12	687 306 H?	113,00		
4,6	24	66	6	687 246 H?	49,25	10,7	55	102	12	687 307 H?	113,00		
4,7	24	66	6	687 247 H?	49,25	10,8	55	102	12	687 308 H?	113,00		
4,8	28	66	6	687 248 H?	49,25	10,9	55	102	12	687 309 H?	113,00		
4,9	28	66	6	687 249 H?	49,25	11,0	55	102	12	687 310 H?	113,00		
5,0	28	66	6	687 250 H?	49,25	11,1	55	102	12	687 311 H?	113,00		
5,1	28	66	6	687 251 H?	49,25	11,2	55	102	12	687 312 H?	113,00		
5,2	28	66	6	687 252 H?	49,25	11,3	55	102	12	687 313 H?	113,00		
5,3	28	66	6	687 253 H?	49,25	11,4	55	102	12	687 314 H?	113,00		
5,4	28	66	6	687 254 H?	49,25	11,5	55	102	12	687 315 H?	113,00		
5,5	28	66	6	687 255 H?	49,25	11,6	55	102	12	687 316 H?	113,00		
5,6	28	66	6	687 256 H?	49,25	11,7	55	102	12	687 317 H?	113,00		
5,7	28	66	6	687 257 H?	49,25	11,8	55	102	12	687 318 H?	113,00		
5,8	28	66	6	687 258 H?	49,25	11,9	55	102	12	687 319 H?	113,00		
5,9	28	66	6	687 259 H?	49,25	12,0	55	102	12	687 320 H?	113,00		
6,0	28	66	6	687 260 H?	49,25	12,2	60	107	14	687 322 H?	149,00		
6,1	34	79	8	687 261 H?	65,00	12,5	60	107	14	687 325 H?	149,00		
6,2	34	79	8	687 262 H?	65,00	12,8	60	107	14	687 328 H?	149,00		
6,3	34	79	8	687 263 H?	65,00	13,0	60	107	14	687 330 H?	149,00		
6,4	34	79	8	687 264 H?	65,00	13,5	60	107	14	687 335 H?	149,00		
6,5	34	79	8	687 265 H?	65,00	13,8	60	107	14	687 338 H?	149,00		
6,6	34	79	8	687 266 H?	65,00	14,0	60	107	14	687 340 H?	149,00		
6,7	34	79	8	687 267 H?	65,00	14,2	65	115	16	687 342 H?	180,00		
6,8	34	79	8	687 268 H?	65,00	14,5	65	115	16	687 345 H?	180,00		
6,9	34	79	8	687 269 H?	65,00	15,0	65	115	16	687 350 H?	180,00		
7,0	34	79	8	687 270 H?	65,00	15,5	65	115	16	687 355 H?	180,00		
7,1	41	79	8	687 271 H?	65,00	16,0	65	115	16	687 360 H?	180,00		
7,2	41	79	8	687 272 H?	65,00	16,5	73	123	18	687 365 H?	272,00		
7,3	41	79	8	687 273 H?	65,00	17,0	73	123	18	687 370 H?	272,00		
7,4	41	79	8	687 274 H?	65,00	17,5	73	123	18	687 375 H?	272,00		
7,5	41	79	8	687 275 H?	65,00	18,0	73	123	18	687 380 H?	272,00		
7,6	41	79	8	687 276 H?	65,00	18,5	79	131	20	687 385 H?	312,00		
7,7	41	79	8	687 277 H?	65,00	19,0	79	131	20	687 390 H?	312,00		
7,8	41	79	8	687 278 H?	65,00	19,5	79	131	20	687 395 H?	312,00		
7,9	41	79	8	687 279 H?	65,00	20,0	79	131	20	687 400 H?	312,00		
8,0	41	79	8	687 280 H?	65,00								

SELECT / DRILL  
by WEXO®

Andere Abmessungen auf Anfrage · Other sizes upon request · Autres dimensions sur demande · Altre dimensioni a richiesta

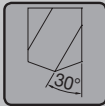

VHM

d<sub>1</sub> = m7  
d<sub>2</sub> = h6

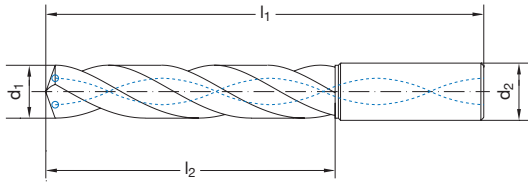

Katalog-Nr. <sup>W%</sup> Catalogue no. <sup>W%</sup> Catalogue n° <sup>W%</sup> Nr. di catalogo <sup>W%</sup>				VAS5DIKTA-HM <sup>880</sup>			Katalog-Nr. <sup>W%</sup> Catalogue no. <sup>W%</sup> Catalogue n° <sup>W%</sup> Nr. di catalogo <sup>W%</sup>				VAS5DIKTA-HM <sup>880</sup>		
				TiAIN							TiAIN		
d <sub>1</sub> [mm]	l <sub>2</sub> [mm]	l <sub>1</sub> [mm]	d <sub>2</sub> [mm]	Code	€	d <sub>1</sub> [mm]	l <sub>2</sub> [mm]	l <sub>1</sub> [mm]	d <sub>2</sub> [mm]	Code	€		
1,0	8	55	4	687 410 HA	63,50	6,1	53	91	8	687 461 H?	71,50		
1,1	12	55	4	687 411 HA	63,50	6,2	53	91	8	687 462 H?	71,50		
1,2	12	55	4	687 412 HA	63,50	6,25	53	91	8	687 4625 H?	71,50		
1,3	12	55	4	687 413 HA	63,50	6,3	53	91	8	687 463 H?	71,50		
1,4	12	55	4	687 414 HA	63,50	6,4	53	91	8	687 464 H?	71,50		
1,5	12	55	4	687 415 HA	63,50	6,5	53	91	8	687 465 H?	71,50		
1,6	16	55	4	687 416 HA	63,50	6,6	53	91	8	687 466 H?	71,50		
1,7	16	55	4	687 417 HA	63,50	6,7	53	91	8	687 467 H?	71,50		
1,8	16	55	4	687 418 HA	63,50	6,8	53	91	8	687 468 H?	71,50		
1,9	16	55	4	687 419 HA	63,50	6,9	53	91	8	687 469 H?	71,50		
2,0	21	57	4	687 420 HA	63,50	7,0	53	91	8	687 470 H?	71,50		
2,05	21	57	4	687 4205 HA	63,50	7,1	53	91	8	687 471 H?	71,50		
2,1	21	57	4	687 421 HA	63,50	7,2	53	91	8	687 472 H?	71,50		
2,2	21	57	4	687 422 HA	63,50	7,3	53	91	8	687 473 H?	71,50		
2,3	21	57	4	687 423 HA	63,50	7,4	53	91	8	687 474 H?	71,50		
2,4	21	57	4	687 424 HA	63,50	7,45	53	91	8	687 4745 H?	71,50		
2,5	21	57	4	687 425 HA	63,50	7,5	53	91	8	687 475 H?	71,50		
2,6	21	57	4	687 426 HA	63,50	7,55	53	91	8	687 4755 H?	71,50		
2,65	21	57	4	687 4265 HA	63,50	7,6	53	91	8	687 476 H?	71,50		
2,7	21	57	4	687 427 HA	63,50	7,7	53	91	8	687 477 H?	71,50		
2,8	21	57	4	687 428 HA	63,50	7,8	53	91	8	687 478 H?	71,50		
2,85	21	57	4	687 4285 HA	63,50	7,9	53	91	8	687 479 H?	71,50		
2,9	21	57	4	687 429 HA	63,50	8,0	53	91	8	687 480 H?	71,50		
3,0	28	66	6	687 430 H?	63,50	8,1	61	103	10	687 481 H?	83,00		
3,1	28	66	6	687 431 H?	63,50	8,2	61	103	10	687 482 H?	83,00		
3,2	28	66	6	687 432 H?	63,50	8,25	61	103	10	687 4825 H?	83,00		
3,25	28	66	6	687 4325 H?	63,50	8,3	61	103	10	687 483 H?	83,00		
3,3	28	66	6	687 433 H?	63,50	8,4	61	103	10	687 484 H?	83,00		
3,4	28	66	6	687 434 H?	63,50	8,45	61	103	10	687 4845 H?	83,00		
3,5	28	66	6	687 435 H?	63,50	8,5	61	103	10	687 485 H?	83,00		
3,6	28	66	6	687 436 H?	63,50	8,6	61	103	10	687 486 H?	83,00		
3,7	28	66	6	687 437 H?	63,50	8,7	61	103	10	687 487 H?	83,00		
3,8	36	74	6	687 438 H?	63,50	8,8	61	103	10	687 488 H?	83,00		
3,9	36	74	6	687 439 H?	63,50	8,9	61	103	10	687 489 H?	83,00		
4,0	36	74	6	687 440 H?	63,50	9,0	61	103	10	687 490 H?	83,00		
4,1	36	74	6	687 441 H?	63,50	9,1	61	103	10	687 491 H?	83,00		
4,2	36	74	6	687 442 H?	63,50	9,2	61	103	10	687 492 H?	83,00		
4,3	36	74	6	687 443 H?	63,50	9,25	61	103	10	687 4925 H?	83,00		
4,4	36	74	6	687 444 H?	63,50	9,3	61	103	10	687 493 H?	83,00		
4,5	36	74	6	687 445 H?	63,50	9,35	61	103	10	687 4935 H?	83,00		
4,6	36	74	6	687 446 H?	63,50	9,4	61	103	10	687 494 H?	83,00		
4,65	36	74	6	687 4465 H?	63,50	9,45	61	103	10	687 4945 H?	83,00		
4,7	36	74	6	687 447 H?	63,50	9,5	61	103	10	687 495 H?	83,00		
4,8	44	82	6	687 448 H?	63,50	9,6	61	103	10	687 496 H?	83,00		
4,9	44	82	6	687 449 H?	63,50	9,7	61	103	10	687 497 H?	83,00		
5,0	44	82	6	687 450 H?	63,50	9,8	61	103	10	687 498 H?	83,00		
5,1	44	82	6	687 451 H?	63,50	9,9	61	103	10	687 499 H?	83,00		
5,2	44	82	6	687 452 H?	63,50	10,0	61	103	10	687 500 H?	83,00		
5,3	44	82	6	687 453 H?	63,50	10,1	71	118	12	687 501 H?	116,00		
5,4	44	82	6	687 454 H?	63,50	10,2	71	118	12	687 502 H?	116,00		
5,5	44	82	6	687 455 H?	63,50	10,3	71	118	12	687 503 H?	116,00		
5,55	44	82	6	687 4555 H?	63,50	10,4	71	118	12	687 504 H?	116,00		
5,6	44	82	6	687 456 H?	63,50	10,5	71	118	12	687 505 H?	116,00		
5,7	44	82	6	687 457 H?	63,50	10,6	71	118	12	687 506 H?	116,00		
5,8	44	82	6	687 458 H?	63,50	10,7	71	118	12	687 507 H?	116,00		
5,9	44	82	6	687 459 H?	63,50	10,8	71	118	12	687 508 H?	116,00		
6,0	44	82	6	687 460 H?	63,50	10,9	71	118	12	687 509 H?	116,00		

SELECT / DRILL  
by WEXO<sup>®</sup>

Andere Abmessungen auf Anfrage · Other sizes upon request · Autres dimensions sur demande · Altre dimensioni a richiesta



DIN 6537L

Typ VA

5 x d IKZ

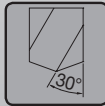

d<sub>1</sub> = m7  
d<sub>2</sub> = h6

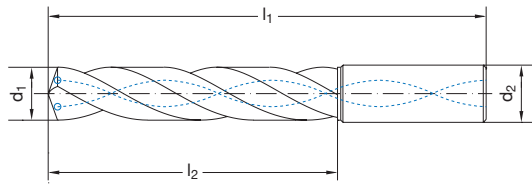

VHM

Katalog-Nr. <sup>W%</sup> Catalogue no. <sup>W%</sup> Catalogue n° <sup>W%</sup> Nr. di catalogo <sup>W%</sup>				VAS5DIKTA-HM <sup>880</sup>			Katalog-Nr. <sup>W%</sup> Catalogue no. <sup>W%</sup> Catalogue n° <sup>W%</sup> Nr. di catalogo <sup>W%</sup>				VAS5DIKTA-HM <sup>880</sup>		
				TiAlN							TiAlN		
d <sub>1</sub> [mm]	l <sub>2</sub> [mm]	l <sub>1</sub> [mm]	d <sub>2</sub> [mm]	Code	€	d <sub>1</sub> [mm]	l <sub>2</sub> [mm]	l <sub>1</sub> [mm]	d <sub>2</sub> [mm]	Code	€		
11,0	71	118	12	687 510	H? 116,00	14,0	77	124	14	687 540	H? 158,00		
11,1	71	118	12	687 511	H? 116,00	14,2	83	133	16	687 542	H? 192,00		
11,2	71	118	12	687 512	H? 116,00	14,5	83	133	16	687 545	H? 192,00		
11,3	71	118	12	687 513	H? 116,00	14,8	83	133	16	687 548	H? 192,00		
11,4	71	118	12	687 514	H? 116,00	15,0	83	133	16	687 550	H? 192,00		
11,5	71	118	12	687 515	H? 116,00	15,2	83	133	16	687 552	H? 192,00		
11,6	71	118	12	687 516	H? 116,00	15,3	83	133	16	687 553	H? 192,00		
11,7	71	118	12	687 517	H? 116,00	15,5	83	133	16	687 555	H? 192,00		
11,8	71	118	12	687 518	H? 116,00	15,8	83	133	16	687 558	H? 192,00		
11,9	71	118	12	687 519	H? 116,00	16,0	83	133	16	687 560	H? 192,00		
12,0	71	118	12	687 520	H? 116,00	16,5	93	143	18	687 565	H? 310,00		
12,2	77	124	14	687 522	H? 158,00	17,0	93	143	18	687 570	H? 310,00		
12,5	77	124	14	687 525	H? 158,00	17,5	93	143	18	687 575	H? 310,00		
12,8	77	124	14	687 528	H? 158,00	18,0	93	143	18	687 580	H? 310,00		
13,0	77	124	14	687 530	H? 158,00	18,5	101	153	20	687 585	H? 332,00		
13,3	77	124	14	687 533	H? 158,00	19,0	101	153	20	687 590	H? 332,00		
13,5	77	124	14	687 535	H? 158,00	19,5	101	153	20	687 595	H? 332,00		
13,8	77	124	14	687 538	H? 158,00	20,0	101	153	20	687 600	H? 332,00		

SELECT / DRILL  
by WEXO<sup>®</sup>

Andere Abmessungen auf Anfrage · Other sizes upon request · Autres dimensions sur demande · Altre dimensioni a richiesta

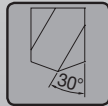

VHM

$d_1 = h7$   
 $d_2 = h6$

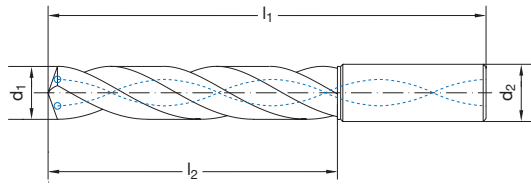

Katalog-Nr. <sup>W%</sup> Catalogue no. <sup>W%</sup> Catalogue n° <sup>W%</sup> Nr. di catalogo <sup>W%</sup>				VAS8DIKTA-HM <sup>880</sup>			Katalog-Nr. <sup>W%</sup> Catalogue no. <sup>W%</sup> Catalogue n° <sup>W%</sup> Nr. di catalogo <sup>W%</sup>				VAS8DIKTA-HM <sup>880</sup>		
				TiAIN							TiAIN		
d <sub>1</sub> [mm]	l <sub>2</sub> [mm]	l <sub>1</sub> [mm]	d <sub>2</sub> [mm]	Code	€	d <sub>1</sub> [mm]	l <sub>2</sub> [mm]	l <sub>1</sub> [mm]	d <sub>2</sub> [mm]	Code	€		
3,0	34	72	6	687 620 H?	125,00	12,5	133	178	14	687 715 H?	376,00		
3,3	34	72	6	687 623 H?	125,00	12,7	133	178	14	687 717 H?	376,00		
3,5	34	72	6	687 625 H?	125,00	13,0	133	178	14	687 720 H?	376,00		
4,0	43	81	6	687 630 H?	125,00	13,5	133	178	14	687 725 H?	376,00		
4,2	43	81	6	687 632 H?	125,00	14,0	133	178	14	687 730 H?	376,00		
4,5	43	81	6	687 635 H?	125,00	14,5	152	203	16	687 735 H?	510,00		
5,0	57	95	6	687 640 H?	125,00	15,0	152	203	16	687 740 H?	510,00		
5,5	57	95	6	687 645 H?	125,00	15,5	152	203	16	687 745 H?	510,00		
6,0	57	95	6	687 650 H?	125,00	16,0	152	203	16	687 750 H?	510,00		
6,5	76	114	8	687 655 H?	155,00	16,5	171	222	18	687 755 H?	630,00		
6,8	76	114	8	687 658 H?	155,00	17,0	171	222	18	687 760 H?	630,00		
7,0	76	114	8	687 660 H?	155,00	17,5	171	222	18	687 765 H?	630,00		
7,5	76	114	8	687 665 H?	155,00	18,0	171	222	18	687 770 H?	630,00		
7,8	76	114	8	687 668 H?	155,00	18,5	190	243	20	687 775 H?	740,00		
8,0	76	114	8	687 670 H?	155,00	19,0	190	243	20	687 780 H?	740,00		
8,5	95	142	10	687 675 H?	196,00	19,5	190	243	20	687 785 H?	740,00		
9,0	95	142	10	687 680 H?	196,00	20,0	190	243	20	687 790 H?	740,00		
9,5	95	142	10	687 685 H?	196,00								
10,0	95	142	10	687 690 H?	196,00								
10,2	114	162	12	687 692 H?	266,00								
10,5	114	162	12	687 695 H?	266,00								
11,0	114	162	12	687 700 H?	266,00								
11,5	114	162	12	687 705 H?	266,00								
12,0	114	162	12	687 710 H?	266,00								

by WEXO<sup>®</sup>  
SELECT / DRILL

Andere Abmessungen auf Anfrage · Other sizes upon request · Autres dimensions sur demande · Altre dimensioni a richiesta

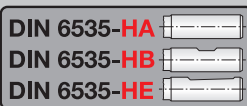
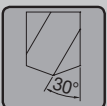

d<sub>1</sub> = h7  
d<sub>2</sub> = h6

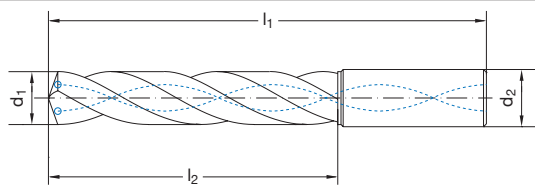

VHM

Katalog-Nr. <sup>W%</sup> Catalogue no. <sup>W%</sup> Catalogue n° <sup>W%</sup> Nr. di catalogo <sup>W%</sup>				VAS12DIKTA-HM <sup>880</sup>			Katalog-Nr. <sup>W%</sup> Catalogue no. <sup>W%</sup> Catalogue n° <sup>W%</sup> Nr. di catalogo <sup>W%</sup>				VAS12DIKTA-HM <sup>880</sup>		
				TiAlN							TiAlN		
d <sub>1</sub> [mm]	l <sub>2</sub> [mm]	l <sub>1</sub> [mm]	d <sub>2</sub> [mm]	Code	€	d <sub>1</sub> [mm]	l <sub>2</sub> [mm]	l <sub>1</sub> [mm]	d <sub>2</sub> [mm]	Code	€		
3,0	54	92	6	687 800 H?	164,00	12,5	182	230	14	687 895 H?	484,00		
3,3	54	92	6	687 803 H?	164,00	12,7	182	230	14	687 897 H?	484,00		
3,5	54	92	6	687 805 H?	164,00	13,0	182	230	14	687 900 H?	484,00		
4,0	64	102	6	687 810 H?	164,00	13,5	182	230	14	687 905 H?	484,00		
4,2	64	102	6	687 812 H?	164,00	14,0	182	230	14	687 910 H?	484,00		
4,5	64	102	6	687 815 H?	164,00	14,5	208	260	16	687 915 H?	640,00		
5,0	78	116	6	687 820 H?	164,00	15,0	208	260	16	687 920 H?	640,00		
5,5	78	116	6	687 825 H?	164,00	15,5	208	260	16	687 925 H?	640,00		
6,0	78	116	6	687 830 H?	164,00	16,0	208	260	16	687 930 H?	640,00		
6,5	108	146	8	687 835 H?	200,00	16,5	234	285	18	687 935 H?	700,00		
6,8	108	146	8	687 838 H?	200,00	17,0	234	285	18	687 940 H?	700,00		
7,0	108	146	8	687 840 H?	200,00	17,5	234	285	18	687 945 H?	700,00		
7,5	108	146	8	687 845 H?	200,00	18,0	234	285	18	687 950 H?	700,00		
7,8	108	146	8	687 848 H?	200,00	18,5	258	310	20	687 955 H?	850,00		
8,0	108	146	8	687 850 H?	200,00	19,0	258	310	20	687 960 H?	850,00		
8,5	120	162	10	687 855 H?	270,00	19,5	258	310	20	687 965 H?	850,00		
9,0	120	162	10	687 860 H?	270,00	20,0	258	310	20	687 970 H?	850,00		
9,5	120	162	10	687 865 H?	270,00								
10,0	120	162	10	687 870 H?	270,00								
10,2	156	204	12	687 872 H?	376,00								
11,0	156	204	12	687 880 H?	376,00								
11,5	156	204	12	687 885 H?	376,00								
12,0	156	204	12	687 890 H?	376,00								

SELECT / DRILL  
by WEXO<sup>®</sup>

Andere Abmessungen auf Anfrage · Other sizes upon request · Autres dimensions sur demande · Altre dimensioni a richiesta



## NCA90-HM, NCA142-HM

Typ UNI

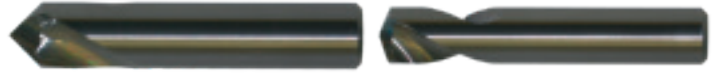

MAT	1.1		1.2.3		1.2.2 + 1.2.4		1.2.1 + 1.3		1.4					
									(<1000 N/mm <sup>2</sup> )		(1000~1200 N/mm <sup>2</sup> )			
$v_c$	40 ~ 50 m/min		40 ~ 60 m/min		30 ~ 40 m/min		35 ~ 45 m/min		30 ~ 40 m/min		20 ~ 30 m/min			
$\varnothing d_1$	n	f	n	f	n	f	n	f	n	f	n	f	n	f
	[min <sup>-1</sup> ]	[mm/U]	[min <sup>-1</sup> ]	[mm/U]	[min <sup>-1</sup> ]	[mm/U]	[min <sup>-1</sup> ]	[mm/U]	[min <sup>-1</sup> ]	[mm/U]	[min <sup>-1</sup> ]	[mm/U]	[min <sup>-1</sup> ]	[mm/U]
3	4.770	0,12	5.310	0,12	3.710	0,12	4.240	0,09	3.710	0,09	2.650	0,09		
4	3.580	0,16	3.980	0,16	2.790	0,16	3.180	0,12	2.790	0,12	1.990	0,12		
6	2.390	0,18	2.650	0,18	1.860	0,18	2.120	0,15	1.860	0,15	1.330	0,15		
8	1.790	0,24	1.990	0,24	1.390	0,24	1.590	0,20	1.390	0,20	990	0,20		
10	1.430	0,30	1.590	0,30	1.110	0,30	1.270	0,20	1.110	0,20	800	0,20		
12	1.190	0,35	1.330	0,35	930	0,35	1.060	0,24	930	0,24	660	0,24		
16	900	0,40	990	0,40	700	0,40	800	0,30	700	0,30	500	0,30		
20	720	0,45	800	0,45	560	0,45	640	0,35	560	0,35	400	0,35		

MAT	1.5						1.6	2	3	4				
	(<1000 N/mm <sup>2</sup> )		(1000~1200 N/mm <sup>2</sup> )		(1200~1500 N/mm <sup>2</sup> )									
$v_c$	25 ~ 35 m/min		20 ~ 30 m/min		15 ~ 25 m/min		10 ~ 20 m/min		40 ~ 50 m/min		40 ~ 60 m/min		80 ~ 100 m/min	
$\varnothing d_1$	n	f	n	f	n	f	n	f	n	f	n	f	n	f
	[min <sup>-1</sup> ]	[mm/U]	[min <sup>-1</sup> ]	[mm/U]	[min <sup>-1</sup> ]	[mm/U]	[min <sup>-1</sup> ]	[mm/U]	[min <sup>-1</sup> ]	[mm/U]	[min <sup>-1</sup> ]	[mm/U]	[min <sup>-1</sup> ]	[mm/U]
3	3.180	0,09	2.650	0,09	2.120	0,09	1.590	0,09	4.770	0,12	5.310	0,12	9.550	0,18
4	2.390	0,12	1.990	0,12	1.590	0,12	1.190	0,12	3.580	0,16	3.980	0,16	7.160	0,24
6	1.590	0,15	1.330	0,15	1.060	0,15	800	0,15	2.390	0,18	2.650	0,18	4.770	0,30
8	1.190	0,20	990	0,20	800	0,20	600	0,20	1.790	0,24	1.990	0,24	3.580	0,32
10	950	0,20	800	0,20	640	0,20	480	0,20	1.430	0,30	1.590	0,30	2.860	0,36
12	800	0,24	660	0,24	530	0,24	400	0,24	1.190	0,35	1.330	0,35	2.390	0,40
16	600	0,30	500	0,30	400	0,30	300	0,30	900	0,40	990	0,40	1.790	0,48
20	480	0,35	400	0,35	320	0,35	240	0,35	720	0,45	800	0,45	1.430	0,60

## NCA90TA-HM, NCA142TA-HM

Typ UNI

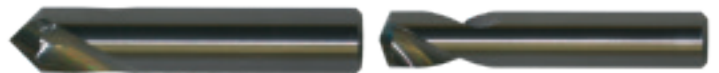

MAT	1.1		1.2.3		1.2.2 + 1.2.4		1.2.1 + 1.3		1.4					
									(<1000 N/mm <sup>2</sup> )		(1000~1200 N/mm <sup>2</sup> )			
$v_c$	70 ~ 80 m/min		70 ~ 90 m/min		60 ~ 70 m/min		65 ~ 75 m/min		60 ~ 70 m/min		50 ~ 60 m/min			
$\varnothing d_1$	n	f	n	f	n	f	n	f	n	f	n	f	n	f
	[min <sup>-1</sup> ]	[mm/U]	[min <sup>-1</sup> ]	[mm/U]	[min <sup>-1</sup> ]	[mm/U]	[min <sup>-1</sup> ]	[mm/U]	[min <sup>-1</sup> ]	[mm/U]	[min <sup>-1</sup> ]	[mm/U]	[min <sup>-1</sup> ]	[mm/U]
3	7.960	0,12	8.490	0,12	6.900	0,12	7.430	0,09	6.900	0,09	5.840	0,09		
4	5.970	0,16	6.370	0,16	5.170	0,16	5.570	0,12	5.170	0,12	4.380	0,12		
6	3.980	0,18	4.240	0,18	3.450	0,18	3.710	0,15	3.450	0,15	2.920	0,15		
8	2.980	0,24	3.180	0,24	2.590	0,24	2.790	0,20	2.590	0,20	2.190	0,20		
10	2.390	0,30	2.550	0,30	2.070	0,30	2.230	0,20	2.070	0,20	1.750	0,20		
12	1.990	0,35	2.120	0,35	1.720	0,35	1.860	0,24	1.720	0,24	1.460	0,24		
16	1.490	0,40	1.590	0,40	1.290	0,40	1.390	0,30	1.290	0,30	1.090	0,30		
20	1.190	0,45	1.270	0,45	1.030	0,45	1.110	0,35	1.030	0,35	880	0,35		

MAT	1.5						1.6	2	3	4				
	(<1000 N/mm <sup>2</sup> )		(1000~1200 N/mm <sup>2</sup> )		(1200~1500 N/mm <sup>2</sup> )									
$v_c$	60 ~ 70 m/min		45 ~ 55 m/min		30 ~ 40 m/min		20 ~ 25 m/min		70 ~ 90 m/min		80 ~ 100 m/min		130 ~ 160 m/min	
$\varnothing d_1$	n	f	n	f	n	f	n	f	n	f	n	f	n	f
	[min <sup>-1</sup> ]	[mm/U]	[min <sup>-1</sup> ]	[mm/U]	[min <sup>-1</sup> ]	[mm/U]	[min <sup>-1</sup> ]	[mm/U]	[min <sup>-1</sup> ]	[mm/U]	[min <sup>-1</sup> ]	[mm/U]	[min <sup>-1</sup> ]	[mm/U]
3	6.900	0,09	5.310	0,09	3.710	0,09	2.390	0,09	8.490	0,12	9.550	0,12	15.380	0,18
4	5.170	0,12	3.980	0,12	2.790	0,12	1.790	0,12	6.370	0,16	7.160	0,16	11.540	0,24
6	3.450	0,15	2.650	0,15	1.860	0,15	1.190	0,15	4.240	0,18	4.770	0,18	7.690	0,30
8	2.590	0,20	1.990	0,20	1.390	0,20	900	0,20	3.180	0,24	3.580	0,24	5.770	0,32
10	2.070	0,20	1.590	0,20	1.110	0,20	720	0,20	2.550	0,30	2.860	0,30	4.620	0,36
12	1.720	0,24	1.330	0,24	930	0,24	600	0,24	2.120	0,35	2.390	0,35	3.850	0,40
16	1.290	0,30	990	0,30	700	0,30	450	0,30	1.590	0,40	1.790	0,40	2.880	0,48
20	1.030	0,35	800	0,35	560	0,35	360	0,35	1.270	0,45	1.430	0,45	2.310	0,60

■ Kühlmittel, Coolant, Lubrification, Lubrificante: Emulsion, Emulsion, Emulsion, Emulsione

## S3DTA-HM

### Typ UNI, 3 x d, VHM-TiAlN



MAT	1.1		1.2.3		1.2.2 + 1.2.4		1.2.1 + 1.3 (<1000 N/mm <sup>2</sup> )		1.4 (1000~ 1200 N/mm <sup>2</sup> )		1.5					
	70 ~ 85 m/min		70 ~ 90 m/min		70 ~ 85 m/min		60 ~ 70 m/min		45 ~ 55 m/min		<1000 N/mm <sup>2</sup>		1000~ 1200 N/mm <sup>2</sup>		1200~ 1500 N/mm <sup>2</sup>	
v <sub>c</sub>																
Ø d <sub>1</sub>	n [min <sup>-1</sup> ]	f [mm/U]	n [min <sup>-1</sup> ]	f [mm/U]	n [min <sup>-1</sup> ]	f [mm/U]	n [min <sup>-1</sup> ]	f [mm/U]	n [min <sup>-1</sup> ]	f [mm/U]	n [min <sup>-1</sup> ]	f [mm/U]	n [min <sup>-1</sup> ]	f [mm/U]	n [min <sup>-1</sup> ]	f [mm/U]
2	11.550	0,07~ 0,09	12.750	0,07~ 0,09	11.150	0,07~ 0,09	9.550	0,04~ 0,05	7.150	0,04~ 0,05	9.550	0,04~ 0,05	7.150	0,04~ 0,05	4.400	0,04~ 0,05
3	7.700	0,13~ 0,16	8.500	0,13~ 0,16	7.450	0,13~ 0,16	6.350	0,06~ 0,08	4.750	0,06~ 0,08	6.350	0,06~ 0,08	4.750	0,06~ 0,08	2.900	0,06~ 0,08
4	5.750	0,13~ 0,16	6.350	0,13~ 0,16	5.550	0,13~ 0,16	4.750	0,06~ 0,08	3.600	0,06~ 0,08	4.750	0,06~ 0,08	3.600	0,06~ 0,08	2.200	0,06~ 0,08
5	4.600	0,13~ 0,16	5.100	0,13~ 0,16	4.450	0,13~ 0,16	3.800	0,06~ 0,08	2.850	0,06~ 0,08	3.800	0,06~ 0,08	2.850	0,06~ 0,08	1.750	0,06~ 0,08
6	3.850	0,18~ 0,22	4.250	0,18~ 0,22	3.700	0,18~ 0,22	3.200	0,10~ 0,12	2.400	0,10~ 0,12	3.200	0,10~ 0,12	2.400	0,10~ 0,12	1.450	0,10~ 0,12
8	2.900	0,18~ 0,22	3.200	0,18~ 0,22	2.800	0,18~ 0,22	2.400	0,10~ 0,12	1.800	0,10~ 0,12	2.400	0,10~ 0,12	1.800	0,10~ 0,12	1.100	0,10~ 0,12
10	2.300	0,22~ 0,28	2.550	0,22~ 0,28	2.250	0,22~ 0,28	1.900	0,12~ 0,15	1.450	0,12~ 0,15	1.900	0,12~ 0,15	1.450	0,12~ 0,15	900	0,12~ 0,15
12	1.900	0,22~ 0,28	2.100	0,22~ 0,28	1.850	0,22~ 0,28	1.600	0,12~ 0,15	1.200	0,12~ 0,15	1.600	0,12~ 0,15	1.200	0,12~ 0,15	750	0,12~ 0,15
14	1.650	0,27~ 0,34	1.800	0,27~ 0,34	1.600	0,27~ 0,34	1.350	0,16~ 0,20	1.000	0,16~ 0,20	1.350	0,16~ 0,20	1.000	0,16~ 0,20	650	0,16~ 0,20
16	1.450	0,27~ 0,34	1.600	0,27~ 0,34	1.400	0,27~ 0,34	1.200	0,16~ 0,20	900	0,16~ 0,20	1.200	0,16~ 0,20	900	0,16~ 0,20	550	0,16~ 0,20
18	1.300	0,30~ 0,38	1.400	0,30~ 0,38	1.250	0,30~ 0,38	1.050	0,20~ 0,25	800	0,20~ 0,25	1.050	0,20~ 0,25	800	0,20~ 0,25	500	0,20~ 0,25
20	1.150	0,30~ 0,38	1.250	0,30~ 0,38	1.100	0,30~ 0,38	950	0,20~ 0,25	700	0,20~ 0,25	950	0,20~ 0,25	700	0,20~ 0,25	450	0,20~ 0,25

MAT	2.1 + 2.2		2.3 + 2.4	
	65 ~ 90 m/min		60 ~ 75 m/min	
v <sub>c</sub>				
Ø d <sub>1</sub>	n [min <sup>-1</sup> ]	f [mm/U]	n [min <sup>-1</sup> ]	f [mm/U]
2	12.750	0,10~ 0,12	11.150	0,06~ 0,07
3	8.500	0,16~ 0,20	7.450	0,10~ 0,12
4	6.350	0,16~ 0,20	5.550	0,10~ 0,12
5	5.100	0,16~ 0,20	4.450	0,10~ 0,12
6	4.250	0,20~ 0,25	3.700	0,14~ 0,17
8	3.200	0,20~ 0,25	2.800	0,14~ 0,17
10	2.550	0,28~ 0,35	2.250	0,18~ 0,22
12	2.100	0,28~ 0,35	1.850	0,18~ 0,22
14	1.800	0,32~ 0,40	1.600	0,24~ 0,30
16	1.600	0,32~ 0,40	1.400	0,24~ 0,30
18	1.400	0,37~ 0,46	1.250	0,30~ 0,37
20	1.250	0,37~ 0,46	1.100	0,30~ 0,37

■ Kühlmittel, Coolant, Lubrification, Lubrificante: Emulsion, Emulsion, Emulsion, Emulsion

SELECT / DRILL  
by WEXO<sup>®</sup>

## S3DIKTA-HM

Typ UNI, 3 x d, VHM-TiAlN-IKZ



MAT	1.1		1.2.3		1.2.2 + 1.2.4		1.2.1 + 1.3 (<1000 N/mm²)		1.4 (1000~1200 N/mm²)		1.5					
	75 ~ 100 m/min		90 ~ 100 m/min		75 ~ 100 m/min		75 ~ 85 m/min		50 ~ 60 m/min		<1000 N/mm²		(1000~1200 N/mm²)		(1200~1500 N/mm²)	
v <sub>c</sub>																
Ø d <sub>1</sub>	n [min <sup>-1</sup> ]	f [mm/U]	n [min <sup>-1</sup> ]	f [mm/U]	n [min <sup>-1</sup> ]	f [mm/U]	n [min <sup>-1</sup> ]	f [mm/U]	n [min <sup>-1</sup> ]	f [mm/U]	n [min <sup>-1</sup> ]	f [mm/U]	n [min <sup>-1</sup> ]	f [mm/U]	n [min <sup>-1</sup> ]	f [mm/U]
3	9.300	0,13~0,16	10.100	0,13~0,16	9.000	0,13~0,16	7.150	0,06~0,08	5.300	0,06~0,08	6.900	0,06~0,08	5.300	0,06~0,08	3.450	0,06~0,08
4	6.950	0,13~0,16	7.550	0,13~0,16	6.750	0,13~0,16	5.350	0,06~0,08	4.000	0,06~0,08	5.150	0,06~0,08	4.000	0,06~0,08	2.600	0,06~0,08
5	5.550	0,13~0,16	6.050	0,13~0,16	5.400	0,13~0,16	4.300	0,06~0,08	3.200	0,06~0,08	4.150	0,06~0,08	3.200	0,06~0,08	2.050	0,06~0,08
6	4.650	0,18~0,22	5.050	0,18~0,22	4.500	0,18~0,22	3.600	0,10~0,12	2.650	0,10~0,12	3.450	0,10~0,12	2.650	0,10~0,12	1.700	0,10~0,12
8	3.500	0,18~0,22	3.800	0,18~0,22	3.400	0,18~0,22	2.700	0,10~0,12	2.000	0,10~0,12	2.600	0,10~0,12	2.000	0,10~0,12	1.300	0,10~0,12
10	2.800	0,22~0,28	3.000	0,22~0,28	2.700	0,22~0,28	2.150	0,12~0,15	1.600	0,12~0,15	2.050	0,12~0,15	1.600	0,12~0,15	1.050	0,12~0,15
12	2.300	0,22~0,28	2.500	0,22~0,28	2.250	0,22~0,28	1.800	0,12~0,15	1.350	0,12~0,15	1.700	0,12~0,15	1.350	0,12~0,15	850	0,12~0,15
14	2.000	0,27~0,34	2.150	0,27~0,34	1.950	0,27~0,34	1.550	0,16~0,20	1.150	0,16~0,20	1.500	0,16~0,20	1.150	0,16~0,20	750	0,16~0,20
16	1.750	0,27~0,34	1.900	0,27~0,34	1.700	0,27~0,34	1.350	0,16~0,20	1.000	0,16~0,20	1.300	0,16~0,20	1.000	0,16~0,20	650	0,16~0,20
18	1.550	0,30~0,38	1.700	0,30~0,38	1.500	0,30~0,38	1.200	0,20~0,25	900	0,20~0,25	1.150	0,20~0,25	900	0,20~0,25	550	0,20~0,25
20	1.400	0,30~0,38	1.500	0,30~0,38	1.350	0,30~0,38	1.050	0,20~0,25	800	0,20~0,25	1.050	0,20~0,25	800	0,20~0,25	500	0,20~0,25

MAT	1.6.1		1.6.2		1.6.3		1.6.4		1.6.5		2.1 + 2.2		2.3 + 2.4		5	
v <sub>c</sub>	50 ~ 60 m/min		35 ~ 50 m/min		30 ~ 45 m/min		45 ~ 55 m/min		25 ~ 30 m/min		80 ~ 110 m/min		70 ~ 100 m/min		25 ~ 30 m/min	
Ø d <sub>1</sub>	n [min <sup>-1</sup> ]	f [mm/U]	n [min <sup>-1</sup> ]	f [mm/U]	n [min <sup>-1</sup> ]	f [mm/U]	n [min <sup>-1</sup> ]	f [mm/U]	n [min <sup>-1</sup> ]	f [mm/U]	n [min <sup>-1</sup> ]	f [mm/U]	n [min <sup>-1</sup> ]	f [mm/U]	n [min <sup>-1</sup> ]	f [mm/U]
3	5.300	0,06~0,08	4.500	0,06~0,08	4.000	0,06~0,08	5.300	0,06~0,08	2.900	0,06~0,08	10.100	0,16~0,20	9.000	0,10~0,12	2.920	0,03~0,04
4	4.000	0,06~0,08	3.400	0,06~0,08	3.000	0,06~0,08	4.000	0,06~0,08	2.200	0,06~0,08	7.550	0,16~0,20	6.750	0,10~0,12	2.190	0,03~0,04
5	3.200	0,06~0,08	2.700	0,06~0,08	2.400	0,06~0,08	3.200	0,06~0,08	1.750	0,06~0,08	6.050	0,16~0,20	5.400	0,10~0,12	1.750	0,03~0,04
6	2.650	0,10~0,12	2.250	0,10~0,12	2.000	0,10~0,12	2.650	0,10~0,12	1.450	0,10~0,12	5.050	0,20~0,25	4.500	0,14~0,17	1.460	0,05~0,08
8	2.000	0,10~0,12	1.700	0,10~0,12	1.500	0,10~0,12	2.000	0,10~0,12	1.100	0,10~0,12	3.800	0,20~0,25	3.400	0,14~0,17	1.100	0,05~0,08
10	1.600	0,12~0,15	1.350	0,12~0,15	1.200	0,12~0,15	1.600	0,12~0,15	900	0,12~0,15	3.000	0,28~0,35	2.700	0,18~0,22	875	0,09~0,12
12	1.350	0,12~0,15	1.150	0,12~0,15	1.000	0,12~0,15	1.350	0,12~0,15	750	0,12~0,15	2.500	0,28~0,35	2.250	0,18~0,22	730	0,09~0,12
14	1.150	0,16~0,20	950	0,16~0,20	850	0,16~0,20	1.150	0,16~0,20	650	0,16~0,20	2.150	0,32~0,40	1.950	0,24~0,30	625	0,13~0,16
16	1.000	0,16~0,20	850	0,16~0,20	750	0,16~0,20	1.000	0,16~0,20	550	0,16~0,20	1.900	0,32~0,40	1.700	0,24~0,30	550	0,13~0,16
18	900	0,20~0,25	750	0,20~0,25	650	0,20~0,25	900	0,20~0,25	500	0,20~0,25	1.700	0,37~0,46	1.500	0,30~0,37	490	0,17~0,20
20	800	0,20~0,25	700	0,20~0,25	600	0,20~0,25	800	0,20~0,25	450	0,20~0,25	1.500	0,37~0,46	1.350	0,30~0,37	400	0,17~0,20

■ Kühlmittel, Coolant, Lubrication, Lubrificante: Emulsion, Emulsion, Emulsion, Emulsion

by WEXO<sup>®</sup>  
**SELECT | DRILL**

## S5DTA-HM

### Typ UNI, 5 x d, VHM-TiAlN-IKZ



MAT	1.1		1.2.3		1.2.2 + 1.2.4		1.2.1 + 1.3 (<1000 N/mm <sup>2</sup> )		1.4 (1000~ 1200 N/mm <sup>2</sup> )		1.5					
	70 ~ 85 m/min		70 ~ 90 m/min		70 ~ 85 m/min		60 ~ 70 m/min		45 ~ 55 m/min		<1000 N/mm <sup>2</sup>		1000~ 1200 N/mm <sup>2</sup>		1200~ 1500 N/mm <sup>2</sup>	
v <sub>c</sub>																
Ø d <sub>1</sub>	n [min <sup>-1</sup> ]	f [mm/U]	n [min <sup>-1</sup> ]	f [mm/U]	n [min <sup>-1</sup> ]	f [mm/U]	n [min <sup>-1</sup> ]	f [mm/U]	n [min <sup>-1</sup> ]	f [mm/U]	n [min <sup>-1</sup> ]	f [mm/U]	n [min <sup>-1</sup> ]	f [mm/U]	n [min <sup>-1</sup> ]	f [mm/U]
2	11.550	0,07~ 0,09	12.750	0,07~ 0,09	11.150	0,07~ 0,09	9.550	0,04~ 0,05	7.150	0,04~ 0,05	9.550	0,04~ 0,05	7.150	0,04~ 0,05	4.400	0,04~ 0,05
3	7.700	0,13~ 0,16	8.500	0,13~ 0,16	7.450	0,13~ 0,16	6.350	0,06~ 0,08	4.750	0,06~ 0,08	6.350	0,06~ 0,08	4.750	0,06~ 0,08	2.900	0,06~ 0,08
4	5.750	0,13~ 0,16	6.350	0,13~ 0,16	5.550	0,13~ 0,16	4.750	0,06~ 0,08	3.600	0,06~ 0,08	4.750	0,06~ 0,08	3.600	0,06~ 0,08	2.200	0,06~ 0,08
5	4.600	0,13~ 0,16	5.100	0,13~ 0,16	4.450	0,13~ 0,16	3.800	0,06~ 0,08	2.850	0,06~ 0,08	3.800	0,06~ 0,08	2.850	0,06~ 0,08	1.750	0,06~ 0,08
6	3.850	0,18~ 0,22	4.250	0,18~ 0,22	3.700	0,18~ 0,22	3.200	0,10~ 0,12	2.400	0,10~ 0,12	3.200	0,10~ 0,12	2.400	0,10~ 0,12	1.450	0,10~ 0,12
8	2.900	0,18~ 0,22	3.200	0,18~ 0,22	2.800	0,18~ 0,22	2.400	0,10~ 0,12	1.800	0,10~ 0,12	2.400	0,10~ 0,12	1.800	0,10~ 0,12	1.100	0,10~ 0,12
10	2.300	0,22~ 0,28	2.550	0,22~ 0,28	2.250	0,22~ 0,28	1.900	0,12~ 0,15	1.450	0,12~ 0,15	1.900	0,12~ 0,15	1.450	0,12~ 0,15	900	0,12~ 0,15
12	1.900	0,22~ 0,28	2.100	0,22~ 0,28	1.850	0,22~ 0,28	1.600	0,12~ 0,15	1.200	0,12~ 0,15	1.600	0,12~ 0,15	1.200	0,12~ 0,15	750	0,12~ 0,15
14	1.650	0,27~ 0,34	1.800	0,27~ 0,34	1.600	0,27~ 0,34	1.350	0,16~ 0,20	1.000	0,16~ 0,20	1.350	0,16~ 0,20	1.000	0,16~ 0,20	650	0,16~ 0,20
16	1.450	0,27~ 0,34	1.600	0,27~ 0,34	1.400	0,27~ 0,34	1.200	0,16~ 0,20	900	0,16~ 0,20	1.200	0,16~ 0,20	900	0,16~ 0,20	550	0,16~ 0,20
18	1.300	0,30~ 0,38	1.400	0,30~ 0,38	1.250	0,30~ 0,38	1.050	0,20~ 0,25	800	0,20~ 0,25	1.050	0,20~ 0,25	800	0,20~ 0,25	500	0,20~ 0,25
20	1.150	0,30~ 0,38	1.250	0,30~ 0,38	1.100	0,30~ 0,38	950	0,20~ 0,25	700	0,20~ 0,25	950	0,20~ 0,25	700	0,20~ 0,25	450	0,20~ 0,25

MAT	2.1 + 2.2		2.3 + 2.4	
	65 ~ 90 m/min		60 ~ 75 m/min	
v <sub>c</sub>				
Ø d <sub>1</sub>	n [min <sup>-1</sup> ]	f [mm/U]	n [min <sup>-1</sup> ]	f [mm/U]
2	12.750	0,10~ 0,12	11.150	0,06~ 0,07
3	8.500	0,16~ 0,20	7.450	0,10~ 0,12
4	6.350	0,16~ 0,20	5.550	0,10~ 0,12
5	5.100	0,16~ 0,20	4.450	0,10~ 0,12
6	4.250	0,20~ 0,25	3.700	0,14~ 0,17
8	3.200	0,20~ 0,25	2.800	0,14~ 0,17
10	2.550	0,28~ 0,35	2.250	0,18~ 0,22
12	2.100	0,28~ 0,35	1.850	0,18~ 0,22
14	1.800	0,32~ 0,40	1.600	0,24~ 0,30
16	1.600	0,32~ 0,40	1.400	0,24~ 0,30
18	1.400	0,37~ 0,46	1.250	0,30~ 0,37
20	1.250	0,37~ 0,46	1.100	0,30~ 0,37

■ Kühlmittel, Coolant, Lubrification, Lubrificante: Emulsion, Emulsion, Emulsion, Emulsion

**SELECT / DRILL**  
by WEXO<sup>®</sup>

## S5DIKTA-HM

Typ UNI, 5 x d, VHM-TiAlN-ikz



MAT	1.1		1.2.3		1.2.2 + 1.2.4		1.2.1 + 1.3 (<1000 N/mm²)		1.4 (1000~1200 N/mm²)		1.5					
	75 ~ 100 m/min		90 ~ 100 m/min		75 ~ 95 m/min		70 ~ 80 m/min		45 ~ 55 m/min		(<1000 N/mm²)		(1000~1200 N/mm²)		(1200~1500 N/mm²)	
v <sub>c</sub>											60 ~ 70 m/min		45 ~ 55 m/min		30 ~ 35 m/min	
Ø d <sub>1</sub>	n [min <sup>-1</sup> ]	f [mm/U]	n [min <sup>-1</sup> ]	f [mm/U]	n [min <sup>-1</sup> ]	f [mm/U]	n [min <sup>-1</sup> ]	f [mm/U]	n [min <sup>-1</sup> ]	f [mm/U]	n [min <sup>-1</sup> ]	f [mm/U]	n [min <sup>-1</sup> ]	f [mm/U]	n [min <sup>-1</sup> ]	f [mm/U]
3	9.300	0,13~0,16	10.100	0,13~0,16	9.000	0,13~0,16	7.150	0,06~0,08	5.300	0,06~0,08	6.900	0,06~0,08	5.300	0,06~0,08	3.450	0,06~0,08
4	6.950	0,13~0,16	7.550	0,13~0,16	6.750	0,13~0,16	5.350	0,06~0,08	4.000	0,06~0,08	5.150	0,06~0,08	4.000	0,06~0,08	2.600	0,06~0,08
5	5.550	0,13~0,16	6.050	0,13~0,16	5.400	0,13~0,16	4.300	0,06~0,08	3.200	0,06~0,08	4.150	0,06~0,08	3.200	0,06~0,08	2.050	0,06~0,08
6	4.650	0,18~0,22	5.050	0,18~0,22	4.500	0,18~0,22	3.600	0,10~0,12	2.650	0,10~0,12	3.450	0,10~0,12	2.650	0,10~0,12	1.700	0,10~0,12
8	3.500	0,18~0,22	3.800	0,18~0,22	3.400	0,18~0,22	2.700	0,10~0,12	2.000	0,10~0,12	2.600	0,10~0,12	2.000	0,10~0,12	1.300	0,10~0,12
10	2.800	0,22~0,28	3.000	0,22~0,28	2.700	0,22~0,28	2.150	0,12~0,15	1.600	0,12~0,15	2.050	0,12~0,15	1.600	0,12~0,15	1.050	0,12~0,15
12	2.300	0,22~0,28	2.500	0,22~0,28	2.250	0,22~0,28	1.800	0,12~0,15	1.350	0,12~0,15	1.700	0,12~0,15	1.350	0,12~0,15	850	0,12~0,15
14	2.000	0,27~0,34	2.150	0,27~0,34	1.950	0,27~0,34	1.550	0,16~0,20	1.150	0,16~0,20	1.500	0,16~0,20	1.150	0,16~0,20	750	0,16~0,20
16	1.750	0,27~0,34	1.900	0,27~0,34	1.700	0,27~0,34	1.350	0,16~0,20	1.000	0,16~0,20	1.300	0,16~0,20	1.000	0,16~0,20	650	0,16~0,20
18	1.550	0,30~0,38	1.700	0,30~0,38	1.500	0,30~0,38	1.200	0,20~0,25	900	0,20~0,25	1.150	0,20~0,25	900	0,20~0,25	550	0,20~0,25
20	1.400	0,30~0,38	1.500	0,30~0,38	1.350	0,30~0,38	1.050	0,20~0,25	800	0,20~0,25	1.050	0,20~0,25	800	0,20~0,25	500	0,20~0,25

MAT	1.6.1		1.6.2		1.6.3		1.6.4		1.6.5		2.1 + 2.2		2.3 + 2.4		5	
v <sub>c</sub>	50 ~ 60 m/min		35 ~ 50 m/min		30 ~ 45 m/min		45 ~ 55 m/min		25 ~ 30 m/min		80 ~ 110 m/min		70 ~ 100 m/min		25 ~ 30 m/min	
Ø d <sub>1</sub>	n [min <sup>-1</sup> ]	f [mm/U]	n [min <sup>-1</sup> ]	f [mm/U]	n [min <sup>-1</sup> ]	f [mm/U]	n [min <sup>-1</sup> ]	f [mm/U]	n [min <sup>-1</sup> ]	f [mm/U]	n [min <sup>-1</sup> ]	f [mm/U]	n [min <sup>-1</sup> ]	f [mm/U]	n [min <sup>-1</sup> ]	f [mm/U]
3	5.300	0,06~0,08	4.500	0,06~0,08	4.000	0,06~0,08	5.300	0,06~0,08	2.900	0,06~0,08	10.100	0,16~0,20	9.000	0,10~0,12	2.920	0,03~0,04
4	4.000	0,06~0,08	3.400	0,06~0,08	3.000	0,06~0,08	4.000	0,06~0,08	2.200	0,06~0,08	7.550	0,16~0,20	6.750	0,10~0,12	2.190	0,03~0,04
5	3.200	0,06~0,08	2.700	0,06~0,08	2.400	0,06~0,08	3.200	0,06~0,08	1.750	0,06~0,08	6.050	0,16~0,20	5.400	0,10~0,12	1.750	0,03~0,04
6	2.650	0,10~0,12	2.250	0,10~0,12	2.000	0,10~0,12	2.650	0,10~0,12	1.450	0,10~0,12	5.050	0,20~0,25	4.500	0,14~0,17	1.460	0,05~0,08
8	2.000	0,10~0,12	1.700	0,10~0,12	1.500	0,10~0,12	2.000	0,10~0,12	1.100	0,10~0,12	3.800	0,20~0,25	3.400	0,14~0,17	1.100	0,05~0,08
10	1.600	0,12~0,15	1.350	0,12~0,15	1.200	0,12~0,15	1.600	0,12~0,15	900	0,12~0,15	3.000	0,28~0,35	2.700	0,18~0,22	875	0,09~0,12
12	1.350	0,12~0,15	1.150	0,12~0,15	1.000	0,12~0,15	1.350	0,12~0,15	750	0,12~0,15	2.500	0,28~0,35	2.250	0,18~0,22	730	0,09~0,12
14	1.150	0,16~0,20	950	0,16~0,20	850	0,16~0,20	1.150	0,16~0,20	650	0,16~0,20	2.150	0,32~0,40	1.950	0,24~0,30	625	0,13~0,16
16	1.000	0,16~0,20	850	0,16~0,20	750	0,16~0,20	1.000	0,16~0,20	550	0,16~0,20	1.900	0,32~0,40	1.700	0,24~0,30	550	0,13~0,16
18	900	0,20~0,25	750	0,20~0,25	650	0,20~0,25	900	0,20~0,25	500	0,20~0,25	1.700	0,37~0,46	1.500	0,30~0,37	490	0,17~0,20
20	800	0,20~0,25	700	0,20~0,25	600	0,20~0,25	800	0,20~0,25	450	0,20~0,25	1.500	0,37~0,46	1.350	0,30~0,37	400	0,17~0,20

■ Kühlmittel, Coolant, Lubrification, Lubrificante: Emulsion, Emulsion, Emulsion, Emulsion

by WEXO<sup>®</sup>  
**SELECT | DRILL**



## S8DIKTA-HM

### Typ UNI, 8 x d, VHM-TiAlN-IKZ



MAT	1.1		1.2.3		1.2.2 + 1.2.4		1.2.1 + 1.3 (<1000 N/mm²)		1.4 (1000~1200 N/mm²)		1.5					
	70 ~ 85 m/min		75 ~ 85 m/min		70 ~ 85 m/min		65 ~ 75 m/min		45 ~ 55 m/min		(<1000 N/mm²)		(1000~1200 N/mm²)		(1200~1500 N/mm²)	
v <sub>c</sub>											60 ~ 70 m/min		45 ~ 55 m/min		30 ~ 35 m/min	
Ø d <sub>1</sub>	n	f	n	f	n	f	n	f	n	f	n	f	n	f	n	f
	[min <sup>-1</sup> ]	[mm/U]	[min <sup>-1</sup> ]	[mm/U]	[min <sup>-1</sup> ]	[mm/U]	[min <sup>-1</sup> ]	[mm/U]	[min <sup>-1</sup> ]	[mm/U]	[min <sup>-1</sup> ]	[mm/U]	[min <sup>-1</sup> ]	[mm/U]	[min <sup>-1</sup> ]	[mm/U]
3	8.200	0,13~ 0,16	8.500	0,13~ 0,16	7.950	0,13~ 0,16	6.900	0,06~ 0,08	5.300	0,06~ 0,08	6.900	0,06~ 0,08	5.300	0,06~ 0,08	3.450	0,06~ 0,08
4	6.150	0,13~ 0,16	6.350	0,13~ 0,16	5.950	0,13~ 0,16	5.150	0,06~ 0,08	4.000	0,06~ 0,08	5.150	0,06~ 0,08	4.000	0,06~ 0,08	2.600	0,06~ 0,08
5	4.950	0,13~ 0,16	5.100	0,13~ 0,16	4.750	0,13~ 0,16	4.150	0,06~ 0,08	3.200	0,06~ 0,08	4.150	0,06~ 0,08	3.200	0,06~ 0,08	2.050	0,06~ 0,08
6	4.100	0,18~ 0,22	4.250	0,18~ 0,22	4.000	0,18~ 0,22	3.450	0,10~ 0,12	2.650	0,10~ 0,12	3.450	0,10~ 0,12	2.650	0,10~ 0,12	1.700	0,10~ 0,12
8	3.100	0,18~ 0,22	3.200	0,18~ 0,22	3.000	0,18~ 0,22	2.600	0,10~ 0,12	2.000	0,10~ 0,12	2.600	0,10~ 0,12	2.000	0,10~ 0,12	1.300	0,10~ 0,12
10	2.450	0,22~ 0,28	2.550	0,22~ 0,28	2.400	0,22~ 0,28	2.050	0,12~ 0,15	1.600	0,12~ 0,15	2.050	0,12~ 0,15	1.600	0,12~ 0,15	1.050	0,12~ 0,15
12	2.050	0,22~ 0,28	2.100	0,22~ 0,28	2.000	0,22~ 0,28	1.700	0,12~ 0,15	1.350	0,12~ 0,15	1.700	0,12~ 0,15	1.350	0,12~ 0,15	850	0,12~ 0,15
14	1.750	0,27~ 0,34	1.800	0,27~ 0,34	1.700	0,27~ 0,34	1.500	0,16~ 0,20	1.150	0,16~ 0,20	1.500	0,16~ 0,20	1.150	0,16~ 0,20	750	0,16~ 0,20
16	1.550	0,27~ 0,34	1.600	0,27~ 0,34	1.500	0,27~ 0,34	1.300	0,16~ 0,20	1.000	0,16~ 0,20	1.300	0,16~ 0,20	1.000	0,16~ 0,20	650	0,16~ 0,20
18	1.350	0,30~ 0,38	1.400	0,30~ 0,38	1.350	0,30~ 0,38	1.150	0,20~ 0,25	900	0,20~ 0,25	1.150	0,20~ 0,25	900	0,20~ 0,25	550	0,20~ 0,25
20	1.250	0,30~ 0,38	1.250	0,30~ 0,38	1.200	0,30~ 0,38	1.050	0,20~ 0,25	800	0,20~ 0,25	1.050	0,20~ 0,25	800	0,20~ 0,25	500	0,20~ 0,25

MAT	1.6.1		1.6.2		1.6.3		1.6.4		1.6.5		2.1 + 2.2		2.3 + 2.4		5	
	55 ~ 75 m/min		50 ~ 70 m/min		45 ~ 65 m/min		55 ~ 75 m/min		30 ~ 45 m/min		70 ~ 95 m/min		65 ~ 85 m/min		25 ~ 30 m/min	
v <sub>c</sub>											70 ~ 95 m/min		65 ~ 85 m/min		25 ~ 30 m/min	
Ø d <sub>1</sub>	n	f	n	f	n	f	n	f	n	f	n	f	n	f	n	f
	[min <sup>-1</sup> ]	[mm/U]	[min <sup>-1</sup> ]	[mm/U]	[min <sup>-1</sup> ]	[mm/U]	[min <sup>-1</sup> ]	[mm/U]	[min <sup>-1</sup> ]	[mm/U]	[min <sup>-1</sup> ]	[mm/U]	[min <sup>-1</sup> ]	[mm/U]	[min <sup>-1</sup> ]	[mm/U]
3	6.900	0,06~ 0,08	6.350	0,06~ 0,08	5.850	0,06~ 0,08	6.900	0,06~ 0,08	4.000	0,06~ 0,08	7.950	0,16~ 0,20	7.150	0,10~ 0,12	2.920	0,03~ 0,04
4	5.150	0,06~ 0,08	4.750	0,06~ 0,08	4.400	0,06~ 0,08	5.150	0,06~ 0,08	3.000	0,06~ 0,08	5.950	0,16~ 0,20	5.350	0,10~ 0,12	2.190	0,03~ 0,04
5	4.150	0,06~ 0,08	3.800	0,06~ 0,08	3.500	0,06~ 0,08	4.150	0,06~ 0,08	2.400	0,06~ 0,08	4.750	0,16~ 0,20	4.300	0,10~ 0,12	1.750	0,03~ 0,04
6	3.450	0,10~ 0,12	3.200	0,10~ 0,12	2.900	0,10~ 0,12	3.450	0,10~ 0,12	2.000	0,10~ 0,12	4.000	0,20~ 0,25	3.600	0,14~ 0,17	1.460	0,05~ 0,08
8	2.600	0,10~ 0,12	2.400	0,10~ 0,12	2.200	0,10~ 0,12	2.600	0,10~ 0,12	1.500	0,10~ 0,12	3.000	0,20~ 0,25	2.700	0,14~ 0,17	1.100	0,05~ 0,08
10	2.050	0,12~ 0,15	1.900	0,12~ 0,15	1.750	0,12~ 0,15	2.050	0,12~ 0,15	1.200	0,12~ 0,15	2.400	0,28~ 0,35	2.150	0,18~ 0,22	875	0,09~ 0,12
12	1.700	0,12~ 0,15	1.600	0,12~ 0,15	1.450	0,12~ 0,15	1.700	0,12~ 0,15	1.000	0,12~ 0,15	2.000	0,28~ 0,35	1.800	0,18~ 0,22	730	0,09~ 0,12
14	1.500	0,16~ 0,20	1.350	0,16~ 0,20	1.250	0,16~ 0,20	1.500	0,16~ 0,20	850	0,16~ 0,20	1.700	0,32~ 0,40	1.550	0,24~ 0,30	625	0,13~ 0,16
16	1.300	0,16~ 0,20	1.200	0,16~ 0,20	1.100	0,16~ 0,20	1.300	0,16~ 0,20	750	0,16~ 0,20	1.500	0,32~ 0,40	1.350	0,24~ 0,30	550	0,13~ 0,16
18	1.150	0,20~ 0,25	1.050	0,20~ 0,25	950	0,20~ 0,25	1.150	0,20~ 0,25	650	0,20~ 0,25	1.350	0,37~ 0,46	1.200	0,30~ 0,37	490	0,17~ 0,20
20	1.050	0,20~ 0,25	950	0,20~ 0,25	900	0,20~ 0,25	1.050	0,20~ 0,25	600	0,20~ 0,25	1.200	0,37~ 0,46	1.050	0,30~ 0,37	400	0,17~ 0,20

**SELECT / DRILL**  
by WEXO<sup>®</sup>

■ Kühlmittel, Coolant, Lubrification, Lubrificante: Emulsion, Emulsion, Emulsion, Emulsion

# S12DIKTA-HM

Typ UNI, 12 x d, VHM-TiAlN-IKZ



MAT	1.1		1.2.3		1.2.2 + 1.2.4		1.2.1 + 1.3 (<1000 N/mm²)		1.4 (1000~1200 N/mm²)		1.5					
	65 ~ 80 m/min		70 ~ 80 m/min		65 ~ 75 m/min		55 ~ 65 m/min		40 ~ 50 m/min		(<1000 N/mm²)		(1000~1200 N/mm²)		(1200~1500 N/mm²)	
v <sub>c</sub>											55 ~ 65 m/min		40 ~ 50 m/min		28 ~ 30 m/min	
Ø d <sub>1</sub>	n [min <sup>-1</sup> ]	f [mm/U]	n [min <sup>-1</sup> ]	f [mm/U]	n [min <sup>-1</sup> ]	f [mm/U]	n [min <sup>-1</sup> ]	f [mm/U]	n [min <sup>-1</sup> ]	f [mm/U]	n [min <sup>-1</sup> ]	f [mm/U]	n [min <sup>-1</sup> ]	f [mm/U]	n [min <sup>-1</sup> ]	f [mm/U]
3	7.700	0,13~0,16	7.950	0,13~0,16	7.450	0,13~0,16	6.350	0,06~0,08	5.300	0,06~0,08	6.350	0,06~0,08	5.300	0,06~0,08	3.100	0,06~0,08
4	5.750	0,13~0,16	5.950	0,13~0,16	5.550	0,13~0,16	4.750	0,06~0,08	4.000	0,06~0,08	4.750	0,06~0,08	4.000	0,06~0,08	2.300	0,06~0,08
5	4.600	0,13~0,16	4.750	0,13~0,16	4.450	0,13~0,16	3.800	0,06~0,08	3.200	0,06~0,08	3.800	0,06~0,08	3.200	0,06~0,08	1.850	0,06~0,08
6	3.850	0,18~0,22	4.000	0,18~0,22	3.700	0,18~0,22	3.200	0,10~0,12	2.650	0,10~0,12	3.200	0,10~0,12	2.650	0,10~0,12	1.550	0,10~0,12
8	2.900	0,18~0,22	3.000	0,18~0,22	2.800	0,18~0,22	2.400	0,10~0,12	2.000	0,10~0,12	2.400	0,10~0,12	2.000	0,10~0,12	1.150	0,10~0,12
10	2.300	0,22~0,28	2.400	0,22~0,28	2.250	0,22~0,28	1.900	0,12~0,15	1.600	0,12~0,15	1.900	0,12~0,15	1.600	0,12~0,15	900	0,12~0,15
12	1.900	0,22~0,28	2.000	0,22~0,28	1.850	0,22~0,28	1.600	0,12~0,15	1.350	0,12~0,15	1.600	0,12~0,15	1.350	0,12~0,15	750	0,12~0,15
14	1.650	0,27~0,34	1.700	0,27~0,34	1.600	0,27~0,34	1.350	0,16~0,20	1.150	0,16~0,20	1.350	0,16~0,20	1.150	0,16~0,20	650	0,16~0,20
16	1.450	0,27~0,34	1.500	0,27~0,34	1.400	0,27~0,34	1.200	0,16~0,20	1.000	0,16~0,20	1.200	0,16~0,20	1.000	0,16~0,20	600	0,16~0,20
18	1.300	0,30~0,38	1.350	0,30~0,38	1.250	0,30~0,38	1.050	0,20~0,25	900	0,20~0,25	1.050	0,20~0,25	900	0,20~0,25	500	0,20~0,25
20	1.150	0,30~0,38	1.200	0,30~0,38	1.100	0,30~0,38	950	0,20~0,25	800	0,20~0,25	950	0,20~0,25	800	0,20~0,25	450	0,20~0,25

MAT	1.6.1		1.6.2		1.6.3		1.6.4		1.6.5		2.1 + 2.2		2.3 + 2.4		5	
	50 ~ 70 m/min		45 ~ 65 m/min		40 ~ 60 m/min		50 ~ 70 m/min		25 ~ 40 m/min		65 ~ 80 m/min		60 ~ 75 m/min		25 ~ 30 m/min	
v <sub>c</sub>											65 ~ 80 m/min		60 ~ 75 m/min		25 ~ 30 m/min	
Ø d <sub>1</sub>	n [min <sup>-1</sup> ]	f [mm/U]	n [min <sup>-1</sup> ]	f [mm/U]	n [min <sup>-1</sup> ]	f [mm/U]	n [min <sup>-1</sup> ]	f [mm/U]	n [min <sup>-1</sup> ]	f [mm/U]	n [min <sup>-1</sup> ]	f [mm/U]	n [min <sup>-1</sup> ]	f [mm/U]	n [min <sup>-1</sup> ]	f [mm/U]
3	6.350	0,06~0,08	5.850	0,06~0,08	5.300	0,06~0,08	6.350	0,06~0,08	3.450	0,06~0,08	7.450	0,16~0,20	6.650	0,10~0,12	2.920	0,03~0,04
4	4.750	0,06~0,08	4.400	0,06~0,08	4.000	0,06~0,08	4.750	0,06~0,08	2.600	0,06~0,08	5.550	0,16~0,20	4.950	0,10~0,12	2.190	0,03~0,04
5	3.800	0,06~0,08	3.500	0,06~0,08	3.200	0,06~0,08	3.800	0,06~0,08	2.050	0,06~0,08	4.450	0,16~0,20	4.000	0,10~0,12	1.750	0,03~0,04
6	3.200	0,10~0,12	2.900	0,10~0,12	2.650	0,10~0,12	3.200	0,10~0,12	1.700	0,10~0,12	3.700	0,20~0,25	3.300	0,14~0,17	1.460	0,05~0,08
8	2.400	0,10~0,12	2.200	0,10~0,12	2.000	0,10~0,12	2.400	0,10~0,12	1.300	0,10~0,12	2.800	0,20~0,25	2.500	0,14~0,17	1.100	0,05~0,08
10	1.900	0,12~0,15	1.750	0,12~0,15	1.600	0,12~0,15	1.900	0,12~0,15	1.050	0,12~0,15	2.250	0,28~0,35	2.000	0,18~0,22	875	0,09~0,12
12	1.600	0,12~0,15	1.450	0,12~0,15	1.350	0,12~0,15	1.600	0,12~0,15	850	0,12~0,15	1.850	0,28~0,35	1.650	0,18~0,22	730	0,09~0,12
14	1.350	0,16~0,20	1.250	0,16~0,20	1.150	0,16~0,20	1.350	0,16~0,20	750	0,16~0,20	1.600	0,32~0,40	1.400	0,24~0,30	625	0,13~0,16
16	1.200	0,16~0,20	1.100	0,16~0,20	1.000	0,16~0,20	1.200	0,16~0,20	650	0,16~0,20	1.400	0,32~0,40	1.250	0,24~0,30	550	0,13~0,16
18	1.050	0,20~0,25	950	0,20~0,25	900	0,20~0,25	1.050	0,20~0,25	550	0,20~0,25	1.250	0,37~0,46	1.100	0,30~0,37	490	0,17~0,20
20	950	0,20~0,25	900	0,20~0,25	800	0,20~0,25	950	0,20~0,25	500	0,20~0,25	1.100	0,37~0,46	1.000	0,30~0,37	400	0,17~0,20

■ Kühlmittel, Coolant, Lubrication, Lubrificante: Emulsion, Emulsion, Emulsion, Emulsion

by WEXO<sup>®</sup>  
**SELECT | DRILL**

## VAS3DIKTA-HM

Typ VA, 3 x d, VHM-TiAlN-IKZ



MAT	1.1		1.2.3		1.2.1		1.6.1		1.6.2		1.6.3 / 1.6.4		1.6.5		1.6.6	
$v_c$	70 ~ 85 m/min		80 ~ 85 m/min		65 ~ 85 m/min		50 ~ 60 m/min		40 ~ 50 m/min		50 ~ 60 m/min		35 ~ 45 m/min		25 ~ 32 m/min	
$\varnothing d_1$	n [min <sup>-1</sup> ]	f [mm/U]	n [min <sup>-1</sup> ]	f [mm/U]	n [min <sup>-1</sup> ]	f [mm/U]	n [min <sup>-1</sup> ]	f [mm/U]	n [min <sup>-1</sup> ]	f [mm/U]	n [min <sup>-1</sup> ]	f [mm/U]	n [min <sup>-1</sup> ]	f [mm/U]	n [min <sup>-1</sup> ]	f [mm/U]
2	12.330	0,05~ 0,08	13.130	0,05~ 0,08	11.940	0,05~ 0,06	8.750	0,05~ 0,06	7.160	0,02~ 0,04	8.750	0,05~ 0,06	6.370	0,02~ 0,04	4.540	0,02~ 0,04
3	8.220	0,08~ 0,11	8.750	0,08~ 0,11	7.960	0,08~ 0,10	5.840	0,08~ 0,10	4.770	0,04~ 0,06	5.840	0,08~ 0,10	4.240	0,04~ 0,06	3.020	0,04~ 0,06
4	6.170	0,10~ 0,13	6.570	0,10~ 0,13	5.970	0,10~ 0,12	4.380	0,10~ 0,12	3.580	0,05~ 0,07	4.380	0,10~ 0,12	3.180	0,05~ 0,07	2.270	0,05~ 0,07
5	4.930	0,11~ 0,15	5.250	0,11~ 0,15	4.770	0,11~ 0,13	3.500	0,11~ 0,13	2.860	0,07~ 0,09	3.500	0,11~ 0,13	2.550	0,07~ 0,09	1.810	0,07~ 0,09
6	4.110	0,12~ 0,16	4.380	0,12~ 0,16	3.980	0,12~ 0,15	2.920	0,12~ 0,15	2.390	0,08~ 0,10	2.920	0,12~ 0,15	2.120	0,08~ 0,10	1.510	0,08~ 0,10
8	3.080	0,15~ 0,20	3.280	0,15~ 0,20	2.980	0,15~ 0,18	2.190	0,15~ 0,18	1.790	0,10~ 0,12	2.190	0,15~ 0,18	1.590	0,10~ 0,12	1.130	0,10~ 0,12
10	2.470	0,18~ 0,24	2.630	0,18~ 0,24	2.390	0,18~ 0,20	1.750	0,18~ 0,20	1.430	0,12~ 0,14	1.750	0,18~ 0,20	1.270	0,12~ 0,14	910	0,12~ 0,14
12	2.060	0,20~ 0,27	2.190	0,20~ 0,27	1.990	0,20~ 0,24	1.460	0,20~ 0,24	1.190	0,14~ 0,16	1.460	0,20~ 0,24	1.060	0,14~ 0,16	760	0,14~ 0,16
14	1.760	0,23~ 0,31	1.880	0,23~ 0,31	1.710	0,23~ 0,25	1.250	0,23~ 0,25	1.020	0,16~ 0,18	1.250	0,23~ 0,25	910	0,16~ 0,18	650	0,16~ 0,18
16	1.540	0,24~ 0,32	1.640	0,24~ 0,32	1.490	0,24~ 0,26	1.090	0,24~ 0,26	900	0,18~ 0,20	1.090	0,24~ 0,26	800	0,18~ 0,20	570	0,18~ 0,20
18	1.370	0,26~ 0,34	1.460	0,26~ 0,34	1.330	0,26~ 0,28	970	0,26~ 0,28	800	0,19~ 0,21	970	0,26~ 0,28	710	0,19~ 0,21	500	0,19~ 0,21
20	1.230	0,27~ 0,36	1.310	0,27~ 0,36	1.190	0,27~ 0,29	880	0,27~ 0,29	720	0,20~ 0,22	880	0,27~ 0,29	640	0,20~ 0,22	450	0,20~ 0,22

MAT	1.4		1.5		3.1 / 3.4		4		5.1 / 5.2	
$v_c$	60 ~ 75 m/min		60 ~ 75 m/min		200 ~ 240 m/min		140 ~ 200 m/min		25 ~ 35 m/min	
$\varnothing d_1$	n [min <sup>-1</sup> ]	f [mm/U]	n [min <sup>-1</sup> ]	f [mm/U]	n [min <sup>-1</sup> ]	f [mm/U]	n [min <sup>-1</sup> ]	f [mm/U]	n [min <sup>-1</sup> ]	f [mm/U]
2	10.740	0,05~ 0,08	10.740	0,05~ 0,06	35.010	0,05~ 0,08	27.060	0,05~ 0,08	4.770	0,005~ 0,008
3	7.160	0,08~ 0,11	7.160	0,08~ 0,10	23.340	0,08~ 0,11	18.040	0,08~ 0,11	3.180	0,010~ 0,015
4	5.370	0,10~ 0,13	5.370	0,10~ 0,12	17.510	0,10~ 0,13	13.530	0,10~ 0,13	2.390	0,020~ 0,025
5	4.300	0,11~ 0,15	4.300	0,11~ 0,13	14.010	0,11~ 0,15	10.820	0,11~ 0,15	1.910	0,030~ 0,035
6	3.580	0,12~ 0,16	3.580	0,12~ 0,15	11.670	0,12~ 0,16	9.020	0,12~ 0,16	1.590	0,035~ 0,045
8	2.690	0,15~ 0,20	2.690	0,15~ 0,18	8.750	0,15~ 0,20	6.760	0,15~ 0,20	1.190	0,050~ 0,060
10	2.150	0,18~ 0,24	2.150	0,18~ 0,20	7.000	0,18~ 0,24	5.410	0,18~ 0,24	950	0,065~ 0,075
12	1.790	0,20~ 0,27	1.790	0,20~ 0,24	5.840	0,20~ 0,27	4.510	0,20~ 0,27	800	0,080~ 0,090
14	1.530	0,23~ 0,31	1.530	0,23~ 0,25	5.000	0,23~ 0,31	3.870	0,23~ 0,31	680	0,095~ 0,105
16	1.340	0,24~ 0,32	1.340	0,24~ 0,26	4.380	0,24~ 0,32	3.380	0,24~ 0,32	600	0,100~ 0,110
18	1.190	0,26~ 0,34	1.190	0,26~ 0,28	3.890	0,26~ 0,34	3.010	0,26~ 0,34	530	0,120~ 0,130
20	1.070	0,27~ 0,36	1.070	0,27~ 0,29	3.500	0,27~ 0,36	2.710	0,27~ 0,36	480	0,125~ 0,135

SELECT / DRILL  
by WEXO<sup>®</sup>

■ Kühlmittel, Coolant, Lubrification, Lubrificante: Emulsion, Emulsion, Emulsion, Emulsione

## VAS5DIKTA-HM

Typ VA, 5 x d, VHM-TiAlN-IKZ



MAT	1.1		1.2.3		1.2.1		1.6.1		1.6.2		1.6.3 / 1.6.4		1.6.5		1.6.6	
$v_c$	70 ~ 85 m/min		80 ~ 85 m/min		65 ~ 85 m/min		50 ~ 60 m/min		40 ~ 50 m/min		50 ~ 60 m/min		35 ~ 45 m/min		25 ~ 32 m/min	
$\varnothing d_1$	n [min <sup>-1</sup> ]	f [mm/U]	n [min <sup>-1</sup> ]	f [mm/U]	n [min <sup>-1</sup> ]	f [mm/U]	n [min <sup>-1</sup> ]	f [mm/U]	n [min <sup>-1</sup> ]	f [mm/U]	n [min <sup>-1</sup> ]	f [mm/U]	n [min <sup>-1</sup> ]	f [mm/U]	n [min <sup>-1</sup> ]	f [mm/U]
1	24.670	0,02~ 0,04	26.260	0,02~ 0,04	23.870	0,02~ 0,03	17.510	0,02~ 0,03	14.320	0,01~ 0,02	17.510	0,02~ 0,03	12.730	0,01~ 0,02	9.070	0,01~ 0,02
2	12.330	0,05~ 0,08	13.130	0,05~ 0,08	11.940	0,05~ 0,06	8.750	0,05~ 0,06	7.160	0,02~ 0,04	8.750	0,05~ 0,06	6.370	0,02~ 0,04	4.540	0,02~ 0,04
3	8.220	0,08~ 0,11	8.750	0,08~ 0,11	7.960	0,08~ 0,10	5.840	0,08~ 0,10	4.770	0,04~ 0,06	5.840	0,08~ 0,10	4.240	0,04~ 0,06	3.020	0,04~ 0,06
4	6.170	0,10~ 0,13	6.570	0,10~ 0,13	5.970	0,10~ 0,12	4.380	0,10~ 0,12	3.580	0,05~ 0,07	4.380	0,10~ 0,12	3.180	0,05~ 0,07	2.270	0,05~ 0,07
5	4.930	0,11~ 0,15	5.250	0,11~ 0,15	4.770	0,11~ 0,13	3.500	0,11~ 0,13	2.860	0,07~ 0,09	3.500	0,11~ 0,13	2.550	0,07~ 0,09	1.810	0,07~ 0,09
6	4.110	0,12~ 0,16	4.380	0,12~ 0,16	3.980	0,12~ 0,15	2.920	0,12~ 0,15	2.390	0,08~ 0,10	2.920	0,12~ 0,15	2.120	0,08~ 0,10	1.510	0,08~ 0,10
8	3.080	0,15~ 0,20	3.280	0,15~ 0,20	2.980	0,15~ 0,18	2.190	0,15~ 0,18	1.790	0,10~ 0,12	2.190	0,15~ 0,18	1.590	0,10~ 0,12	1.130	0,10~ 0,12
10	2.470	0,18~ 0,24	2.630	0,18~ 0,24	2.390	0,18~ 0,20	1.750	0,18~ 0,20	1.430	0,12~ 0,14	1.750	0,18~ 0,20	1.270	0,12~ 0,14	910	0,12~ 0,14
12	2.060	0,20~ 0,27	2.190	0,20~ 0,27	1.990	0,20~ 0,24	1.460	0,20~ 0,24	1.190	0,14~ 0,16	1.460	0,20~ 0,24	1.060	0,14~ 0,16	760	0,14~ 0,16
14	1.760	0,23~ 0,31	1.880	0,23~ 0,31	1.710	0,23~ 0,25	1.250	0,23~ 0,25	1.020	0,16~ 0,18	1.250	0,23~ 0,25	910	0,16~ 0,18	650	0,16~ 0,18
16	1.540	0,24~ 0,32	1.640	0,24~ 0,32	1.490	0,24~ 0,26	1.090	0,24~ 0,26	900	0,18~ 0,20	1.090	0,24~ 0,26	800	0,18~ 0,20	570	0,18~ 0,20
18	1.370	0,26~ 0,34	1.460	0,26~ 0,34	1.330	0,26~ 0,28	970	0,26~ 0,28	800	0,19~ 0,21	970	0,26~ 0,28	710	0,19~ 0,21	500	0,19~ 0,21
20	1.230	0,27~ 0,36	1.310	0,27~ 0,36	1.190	0,27~ 0,29	880	0,27~ 0,29	720	0,20~ 0,22	880	0,27~ 0,29	640	0,20~ 0,22	450	0,20~ 0,22

MAT	1.4		1.5		3.1 / 3.4		4		5.1 / 5.2	
$v_c$	60 ~ 75 m/min		60 ~ 75 m/min		200 ~ 240 m/min		140 ~ 200 m/min		25 ~ 35 m/min	
$\varnothing d_1$	n [min <sup>-1</sup> ]	f [mm/U]	n [min <sup>-1</sup> ]	f [mm/U]	n [min <sup>-1</sup> ]	f [mm/U]	n [min <sup>-1</sup> ]	f [mm/U]	n [min <sup>-1</sup> ]	f [mm/U]
1	21.490	0,02~ 0,04	21.490	0,02~ 0,03	70.030	0,02~ 0,04	54.110	0,02~ 0,04	9.550	0,002~ 0,005
2	10.740	0,05~ 0,08	10.740	0,05~ 0,06	35.010	0,05~ 0,08	27.060	0,05~ 0,08	4.770	0,005~ 0,008
3	7.160	0,08~ 0,11	7.160	0,08~ 0,10	23.340	0,08~ 0,11	18.040	0,08~ 0,11	3.180	0,010~ 0,015
4	5.370	0,10~ 0,13	5.370	0,10~ 0,12	17.510	0,10~ 0,13	13.530	0,10~ 0,13	2.390	0,020~ 0,025
5	4.300	0,11~ 0,15	4.300	0,11~ 0,13	14.010	0,11~ 0,15	10.820	0,11~ 0,15	1.910	0,030~ 0,035
6	3.580	0,12~ 0,16	3.580	0,12~ 0,15	11.670	0,12~ 0,16	9.020	0,12~ 0,16	1.590	0,035~ 0,045
8	2.690	0,15~ 0,20	2.690	0,15~ 0,18	8.750	0,15~ 0,20	6.760	0,15~ 0,20	1.190	0,050~ 0,060
10	2.150	0,18~ 0,24	2.150	0,18~ 0,20	7.000	0,18~ 0,24	5.410	0,18~ 0,24	950	0,065~ 0,075
12	1.790	0,20~ 0,27	1.790	0,20~ 0,24	5.840	0,20~ 0,27	4.510	0,20~ 0,27	800	0,080~ 0,090
14	1.530	0,23~ 0,31	1.530	0,23~ 0,25	5.000	0,23~ 0,31	3.870	0,23~ 0,31	680	0,095~ 0,105
16	1.340	0,24~ 0,32	1.340	0,24~ 0,26	4.380	0,24~ 0,32	3.380	0,24~ 0,32	600	0,100~ 0,110
18	1.190	0,26~ 0,34	1.190	0,26~ 0,28	3.890	0,26~ 0,34	3.010	0,26~ 0,34	530	0,120~ 0,130
20	1.070	0,27~ 0,36	1.070	0,27~ 0,29	3.500	0,27~ 0,36	2.710	0,27~ 0,36	480	0,125~ 0,135

■ Kühlmittel, Coolant, Lubrification, Lubrificante: Emulsion, Emulsion, Emulsion, Emulsione

by WIXO<sup>®</sup>  
**SELECT / DRILL**

## VAS8DIKTA-HM

Typ VA, 8 x d, VHM-TiAlN-IKZ



MAT	1.1		1.2.3		1.2.1 / 1.2.2 / 1.2.4 / 1.3		1.6.1		1.6.2		1.6.3 / 1.6.4		1.6.5		1.6.6	
v <sub>c</sub>	70 ~ 90 m/min		80 ~ 100 m/min		65 ~ 85 m/min		40 ~ 55 m/min		35 ~ 45 m/min		40 ~ 55 m/min		30 ~ 40 m/min		20 ~ 30 m/min	
Ø d <sub>1</sub>	n [min <sup>-1</sup> ]	f [mm/U]	n [min <sup>-1</sup> ]	f [mm/U]	n [min <sup>-1</sup> ]	f [mm/U]	n [min <sup>-1</sup> ]	f [mm/U]	n [min <sup>-1</sup> ]	f [mm/U]	n [min <sup>-1</sup> ]	f [mm/U]	n [min <sup>-1</sup> ]	f [mm/U]	n [min <sup>-1</sup> ]	f [mm/U]
2	12.730	0,04~ 0,06	14.350	0,04~ 0,06	12.000	0,04~ 0,06	7.560	0,03~ 0,04	6.370	0,03~ 0,04	7.560	0,03~ 0,04	5.570	0,03~ 0,04	3.980	0,02~ 0,03
3	8.490	0,07~ 0,08	9.600	0,07~ 0,08	8.000	0,07~ 0,08	5.040	0,04~ 0,06	4.250	0,04~ 0,06	5.040	0,04~ 0,06	3.720	0,04~ 0,06	2.650	0,03~ 0,04
4	6.370	0,10~ 0,12	7.200	0,10~ 0,12	6.000	0,10~ 0,12	3.780	0,07~ 0,08	3.180	0,07~ 0,08	3.780	0,07~ 0,08	2.790	0,07~ 0,08	2.000	0,05~ 0,06
5	5.090	0,12~ 0,14	5.750	0,12~ 0,14	4.800	0,12~ 0,14	3.030	0,08~ 0,09	2.550	0,08~ 0,09	3.030	0,08~ 0,09	2.230	0,08~ 0,09	1.600	0,06~ 0,07
6	4.240	0,14~ 0,16	4.800	0,14~ 0,16	4.000	0,14~ 0,16	2.520	0,10~ 0,11	2.120	0,10~ 0,11	2.520	0,10~ 0,11	1.860	0,10~ 0,11	1.330	0,07~ 0,08
8	3.180	0,16~ 0,18	3.600	0,16~ 0,18	3.000	0,16~ 0,18	1.890	0,12~ 0,13	1.590	0,12~ 0,13	1.890	0,12~ 0,13	1.400	0,12~ 0,13	1.000	0,09~ 0,10
10	2.550	0,19~ 0,20	2.870	0,19~ 0,20	2.400	0,19~ 0,20	1.510	0,14~ 0,15	1.270	0,14~ 0,15	1.510	0,14~ 0,15	1.120	0,14~ 0,15	800	0,11~ 0,12
12	2.120	0,21~ 0,23	2.400	0,21~ 0,23	2.000	0,21~ 0,23	1.260	0,16~ 0,17	1.060	0,16~ 0,17	1.260	0,16~ 0,17	930	0,16~ 0,17	660	0,13~ 0,14
14	1.820	0,24~ 0,26	2.050	0,24~ 0,26	1.700	0,24~ 0,26	1.080	0,18~ 0,19	910	0,18~ 0,19	1.080	0,18~ 0,19	800	0,18~ 0,19	570	0,15~ 0,16
16	1.590	0,27~ 0,29	1.800	0,27~ 0,29	1.500	0,27~ 0,29	950	0,20~ 0,21	800	0,20~ 0,21	950	0,20~ 0,21	700	0,20~ 0,21	500	0,17~ 0,18
18	1.410	0,30~ 0,32	1.600	0,30~ 0,32	1.330	0,30~ 0,32	840	0,22~ 0,23	710	0,22~ 0,23	840	0,22~ 0,23	620	0,22~ 0,23	440	0,19~ 0,20
20	1.270	0,33~ 0,35	1.440	0,33~ 0,35	1.200	0,33~ 0,35	760	0,24~ 0,25	640	0,24~ 0,25	760	0,24~ 0,25	560	0,24~ 0,25	400	0,21~ 0,22

MAT	1.4 (< 1000 N/mm <sup>2</sup> )		1.5 (< 1000 N/mm <sup>2</sup> )		2.1 / 2.2		2.3 / 2.4		5			
	60 ~ 70 m/min		60 ~ 70 m/min		70 ~ 90 m/min		65 ~ 75 m/min		(< 1000 N/mm <sup>2</sup> )		(1000 ~ 1200 N/mm <sup>2</sup> )	
v <sub>c</sub>	60 ~ 70 m/min		60 ~ 70 m/min		70 ~ 90 m/min		65 ~ 75 m/min		25 ~ 35 m/min		20 ~ 30 m/min	
Ø d <sub>1</sub>	n [min <sup>-1</sup> ]	f [mm/U]	n [min <sup>-1</sup> ]	f [mm/U]	n [min <sup>-1</sup> ]	f [mm/U]	n [min <sup>-1</sup> ]	f [mm/U]	n [min <sup>-1</sup> ]	f [mm/U]	n [min <sup>-1</sup> ]	f [mm/U]
2	10.350	0,03~ 0,04	10.350	0,03~ 0,04	12.730	0,07~ 0,09	11.150	0,04~ 0,06	4.770	0,02~ 0,03	3.980	0,02~ 0,03
3	6.900	0,04~ 0,06	6.900	0,04~ 0,06	8.490	0,10~ 0,12	7.430	0,07~ 0,08	3.180	0,03~ 0,05	2.650	0,03~ 0,05
4	5.180	0,07~ 0,08	5.180	0,07~ 0,08	6.370	0,13~ 0,15	5.570	0,10~ 0,12	2.390	0,06~ 0,07	2.000	0,06~ 0,07
5	4.140	0,08~ 0,09	4.140	0,08~ 0,09	5.090	0,15~ 0,17	4.460	0,12~ 0,14	1.910	0,08~ 0,09	1.600	0,08~ 0,09
6	3.450	0,10~ 0,11	3.450	0,10~ 0,11	4.240	0,18~ 0,20	3.720	0,14~ 0,16	1.600	0,09~ 0,10	1.330	0,09~ 0,10
8	2.590	0,12~ 0,13	2.590	0,12~ 0,13	3.180	0,21~ 0,24	2.790	0,16~ 0,18	1.200	0,11~ 0,12	1.000	0,11~ 0,12
10	2.070	0,14~ 0,15	2.070	0,14~ 0,15	2.550	0,26~ 0,29	2.230	0,19~ 0,20	950	0,13~ 0,14	800	0,13~ 0,14
12	1.730	0,16~ 0,17	1.730	0,16~ 0,17	2.120	0,30~ 0,32	1.860	0,21~ 0,23	800	0,15~ 0,16	660	0,15~ 0,16
14	1.480	0,18~ 0,19	1.480	0,18~ 0,19	1.820	0,33~ 0,35	1.600	0,24~ 0,26	680	0,17~ 0,18	570	0,17~ 0,18
16	1.300	0,20~ 0,21	1.300	0,20~ 0,21	1.590	0,36~ 0,38	1.400	0,27~ 0,29	600	0,19~ 0,20	500	0,19~ 0,20
18	1.150	0,22~ 0,23	1.150	0,22~ 0,23	1.410	0,38~ 0,40	1.240	0,30~ 0,32	530	0,21~ 0,22	440	0,21~ 0,22
20	1.040	0,24~ 0,25	1.040	0,24~ 0,25	1.270	0,41~ 0,44	1.120	0,33~ 0,35	480	0,23~ 0,24	400	0,23~ 0,24

Einsatzbedingungen  
Cutting conditions  
Conditions d'utilisation  
Condizioni d'uso



Emulsion  
Emulsion  
Emulsion  
Emulsione



v<sub>c</sub> x 1,05

■ Kühlmittel, Coolant, Lubrification, Lubrificante: Emulsion, Emulsion, Emulsion, Emulsione

SELECT / DRILL  
by WEXO<sup>®</sup>



# VAS12DIKTA-HM

Typ VA, 12 x d, VHM-TiAlN-1KZ



MAT	1.1		1.2.3		1.2.1 / 1.2.2 / 1.2.4 / 1.3		1.6.1		1.6.2		1.6.3 / 1.6.4		1.6.5		1.6.6	
$v_c$	70 ~ 80 m/min		70 ~ 90 m/min		60 ~ 80 m/min		40 ~ 50 m/min		30 ~ 40 m/min		40 ~ 50 m/min		25 ~ 35 m/min		20 ~ 30 m/min	
$\varnothing d_1$	n [min <sup>-1</sup> ]	f [mm/U]	n [min <sup>-1</sup> ]	f [mm/U]	n [min <sup>-1</sup> ]	f [mm/U]	n [min <sup>-1</sup> ]	f [mm/U]	n [min <sup>-1</sup> ]	f [mm/U]	n [min <sup>-1</sup> ]	f [mm/U]	n [min <sup>-1</sup> ]	f [mm/U]	n [min <sup>-1</sup> ]	f [mm/U]
2	12.000	0,04~0,06	12.730	0,04~0,06	11.140	0,04~0,06	7.160	0,03~0,04	5.570	0,03~0,04	7.160	0,03~0,04	5.000	0,03~0,04	3.980	0,02~0,03
3	8.000	0,07~0,08	8.500	0,07~0,08	7.450	0,07~0,08	4.780	0,04~0,06	3.720	0,04~0,06	4.780	0,04~0,06	3.340	0,04~0,06	2.650	0,03~0,04
4	6.000	0,10~0,12	6.400	0,10~0,12	5.570	0,10~0,12	3.580	0,07~0,08	2.790	0,07~0,08	3.580	0,07~0,08	2.500	0,07~0,08	2.000	0,05~0,06
5	4.800	0,12~0,14	5.100	0,12~0,14	4.460	0,12~0,14	2.870	0,08~0,09	2.230	0,08~0,09	2.870	0,08~0,09	2.000	0,08~0,09	1.600	0,06~0,07
6	4.000	0,14~0,16	4.250	0,14~0,16	3.720	0,14~0,16	2.400	0,10~0,11	1.860	0,10~0,11	2.400	0,10~0,11	1.670	0,10~0,11	1.330	0,07~0,08
8	3.000	0,16~0,18	3.200	0,16~0,18	2.790	0,16~0,18	1.800	0,12~0,13	1.400	0,12~0,13	1.800	0,12~0,13	1.250	0,12~0,13	1.000	0,09~0,10
10	2.400	0,19~0,20	2.550	0,19~0,20	2.230	0,19~0,20	1.430	0,14~0,15	1.120	0,14~0,15	1.430	0,14~0,15	1.000	0,14~0,15	800	0,11~0,12
12	2.000	0,21~0,23	2.130	0,21~0,23	1.860	0,21~0,23	1.200	0,16~0,17	930	0,16~0,17	1.200	0,16~0,17	840	0,16~0,17	660	0,13~0,14
14	1.710	0,24~0,26	1.820	0,24~0,26	1.600	0,24~0,26	1.030	0,18~0,19	800	0,18~0,19	1.030	0,18~0,19	720	0,18~0,19	570	0,15~0,16
16	1.500	0,27~0,29	1.600	0,27~0,29	1.400	0,27~0,29	900	0,20~0,21	700	0,20~0,21	900	0,20~0,21	630	0,20~0,21	500	0,17~0,18
18	1.330	0,30~0,32	1.420	0,30~0,32	1.240	0,30~0,32	800	0,22~0,23	620	0,22~0,23	800	0,22~0,23	560	0,22~0,23	440	0,19~0,20
20	1.200	0,33~0,35	1.280	0,33~0,35	1.120	0,33~0,35	720	0,24~0,25	560	0,24~0,25	720	0,24~0,25	500	0,24~0,25	400	0,21~0,22

MAT	1.4 (< 1000 N/mm <sup>2</sup> )		1.5 (< 1000 N/mm <sup>2</sup> )		2.1 / 2.2		2.3 / 2.4		5			
$v_c$	50 ~ 60 m/min		50 ~ 60 m/min		70 ~ 80 m/min		60 ~ 70 m/min		< 1000 N/mm <sup>2</sup>		(1000 ~ 1200 N/mm <sup>2</sup> )	
$\varnothing d_1$	n [min <sup>-1</sup> ]	f [mm/U]	n [min <sup>-1</sup> ]	f [mm/U]	n [min <sup>-1</sup> ]	f [mm/U]	n [min <sup>-1</sup> ]	f [mm/U]	n [min <sup>-1</sup> ]	f [mm/U]	n [min <sup>-1</sup> ]	f [mm/U]
2	8.760	0,03~0,04	8.760	0,03~0,04	12.000	0,07~0,09	10.350	0,04~0,06	3.980	0,02~0,03	3.180	0,02~0,03
3	5.840	0,04~0,06	5.840	0,04~0,06	8.000	0,10~0,12	6.900	0,07~0,08	2.650	0,03~0,05	2.120	0,03~0,04
4	4.380	0,07~0,08	4.380	0,07~0,08	6.000	0,13~0,15	5.180	0,10~0,12	2.000	0,06~0,07	1.600	0,05~0,06
5	3.500	0,08~0,09	3.500	0,08~0,09	4.800	0,15~0,17	4.140	0,12~0,14	1.600	0,08~0,09	1.270	0,06~0,07
6	2.920	0,10~0,11	2.920	0,10~0,11	4.000	0,18~0,20	3.450	0,14~0,16	1.330	0,09~0,10	1.060	0,07~0,08
8	2.190	0,12~0,13	2.190	0,12~0,13	3.000	0,21~0,24	2.590	0,16~0,18	1.000	0,11~0,12	800	0,09~0,10
10	1.750	0,14~0,15	1.750	0,14~0,15	2.400	0,26~0,29	2.070	0,19~0,20	800	0,13~0,14	640	0,11~0,12
12	1.460	0,16~0,17	1.460	0,16~0,17	2.000	0,30~0,32	1.730	0,21~0,23	660	0,15~0,16	530	0,13~0,14
14	1.250	0,18~0,19	1.250	0,18~0,19	1.710	0,33~0,35	1.480	0,24~0,26	570	0,17~0,18	450	0,15~0,16
16	1.100	0,20~0,21	1.100	0,20~0,21	1.500	0,36~0,38	1.300	0,27~0,29	500	0,19~0,20	400	0,17~0,18
18	970	0,22~0,23	970	0,22~0,23	1.330	0,38~0,40	1.150	0,30~0,32	440	0,21~0,22	350	0,19~0,20
20	875	0,24~0,25	875	0,24~0,25	1.200	0,41~0,44	1.040	0,33~0,35	400	0,23~0,24	320	0,21~0,22

Einsatzbedingungen  
Cutting conditions  
Conditions d'utilisation  
Condizioni d'uso



Emulsion  
Emulsion  
Emulsion  
Emulsione



$v_c \times 1,05$



































































































■ Kühlmittel, Coolant, Lubrification, Lubrificante: Emulsion, Emulsion, Emulsion, Emulsione

by WIXO<sup>®</sup>  
SELECT / DRILL



**SELECT / MILL**  
by WEXO<sup>®</sup>

**SELECT / MILL**  
by WEXO<sup>®</sup>

<b>E90TA-HM</b> Entgräter 90°, Deburrer 90°, Fraise à ébavurer à 90°, Frese per smussi 90°	49
        	
<b>RK2TA-HM, RN2TA-HM</b> Radiusfräser, Ball nose end mill, Fraise hémisphérique, Frese sferiche	50
       	
<b>RL2LHTA-HM</b> Radiusfräser langer Hals, Ball nose end mill long neck, Fraise hémisphérique avec grande longueur dégagée, Frese sferiche con collo lungo	51
       	
<b>TL2LHTA-HM</b> Torusfräser langer Hals, Corner radius end mill long neck, Fraise torique avec grande longueur dégagée, Frese toriche con collo lungo	52
       	
<b>SL2LHTA-HM</b> Schafffräser langer Hals, End mill long neck, Fraises deux tailles avec grande longueur dégagée, Frese a candela con collo lungo	53
       	
<b>SK3TA-HM, SL3TA-HM</b> Bohrnutenfräser, Slot Mill, Fraise à rainurer, Fresa per scanalature	54
       	
<b>TN4HFTA-HM, TL4HFTA-HM</b> Hoch-Vorschub Torusfräser, High-Feed corner radius end mill, Fraise torique à grande avance, Frese toriche ad alto avanzamento	55
       	
<b>TN4TA-HM</b> Torusfräser, Corner radius end mill, Fraise torique, Frese toriche	56
       	
<b>SK4UGTA-HM, SL4UGTA-HM</b> Schafffräser mit ungleichem Drillwinkel, End mill with irregular helix angles, Fraise avec angles d'hélice irréguliers, Frese a candela con angolo dell'elica irregolare	57
       	
<b>SL4HRTA-HM</b> HPC-Schafffräser mit ungleicher Teilung, HPC-End mill with irregular indexing, HPC-Fraise à pas décalés, Frese HPC con passo differenziato	58
       	
<b>SLHRTA-HM</b> Schruppfräser, Roughing end mill, Fraise d'ébauche, Frese a sgrossare	59
       	
<b>SKMZTA-HM</b> Schafffräser, End Mill, Fraises deux tailles, Frese a candela	60
         	

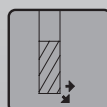
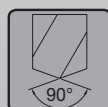
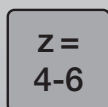

$d_2 = h6$

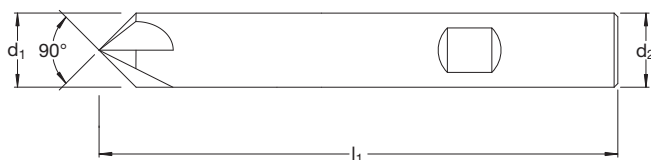

Katalog-Nr. W% Catalogue n° W%		Catalogue no. W% Nr. di catalogo W%		E90TA-HM <sup>780</sup>			
				TiAlN			
d <sub>1</sub> [mm]	l <sub>1</sub> [mm]	d <sub>2</sub> [mm]	z	Code	€		
4	54	4	4	655 701	28,50		
6	57	6	4	655 702	33,00		
8	63	8	5	655 703	40,50		
10	72	10	6	655 704	49,00		
12	83	12	6	655 705	73,00		
Satz, Set, Kit, Serie Ø 6 - 8 - 10 - 12 mm				655 980	181,00		
d <sub>2</sub> < 6,0mm							
Schaftausführung DIN 6535 HA							
Shank design DIN 6535 HA							
Queue selon DIN 6535 HA							
Gambo DIN 6535 HA							



**SELECT / MILL**  
by WEXO®

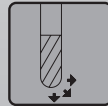
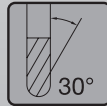
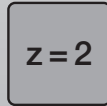

R = ±0,010

d<sub>2</sub> = h6

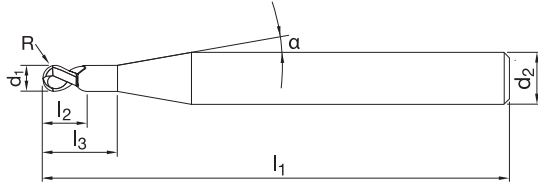

Katalog-Nr. W%		Catalogue no. W%		RK2TA-HM <sup>780</sup>		RN2TA-HM <sup>780</sup>		
Catalogue n° W%		Nr. di catalogo W%		TiAlN		TiAlN		
d <sub>1</sub> [mm]	R [mm]	l <sub>3</sub> [mm]	l <sub>2</sub> [mm]	α [°]	l <sub>1</sub> [mm]	d <sub>2</sub> [mm]	Code	€
1	0,5	2,5	1,5	10	50	6	655 020	25,75
2	1	6	3	10	50	6	655 022	25,75
3	1,5	8	4,5	10	50	6	655 024	25,75
4	2	8	6	10	50	6	655 026	25,75
5	2,5	12	7,5	10	50	6	655 028	25,75
6	3	-	9	-	50	6	655 030	25,75
8	4	-	12	-	60	8	655 032	40,50
10	5	-	15	-	75	10	655 034	65,50
12	6	-	18	-	75	12	655 036	76,00
3	1,5	12,5	8	-	60	6	655 961	33,00
4	2	13	8	-	70	6	655 963	36,25
5	2,5	16,5	10	-	80	6	655 965	39,75
6	3	-	12	-	90	6	655 966	40,75
8	4	-	14	-	100	8	655 968	62,50
10	5	-	18	-	100	10	655 970	96,00
12	6	-	22	-	110	12	655 972	127,00



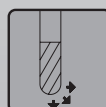
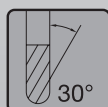
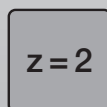

R = ±0,010

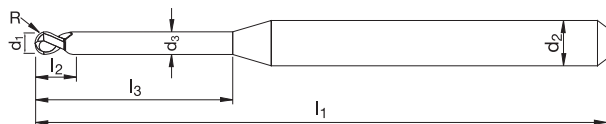
d<sub>2</sub> = h6

Katalog-Nr. <sup>W%</sup> Catalogue n <sup>o</sup> W%		Catalogue no. <sup>W%</sup> Nr. di catalogo <sup>W%</sup>		RL2LHTA-HM <sup>780</sup>					
				TiAlN					
d <sub>1</sub> [mm]	R [mm]	l <sub>3</sub> [mm]	l <sub>2</sub> [mm]	d <sub>3</sub> [mm]	l <sub>1</sub> [mm]	d <sub>2</sub> [mm]	Code	€	
0,5	0,25	2	0,75	0,45	45	4	655 064	45,75	
0,6	0,3	6	0,9	0,55	45	4	655 040	45,75	
0,8	0,4	6	1,2	0,75	45	4	655 041	45,75	
0,8	0,4	8	1,2	0,75	45	4	655 042	45,75	
1	0,5	6	1,5	0,95	45	4	655 043	45,75	
1	0,5	8	1,5	0,95	45	4	655 044	45,75	
1	0,5	10	1,5	0,95	45	4	655 045	45,75	
1	0,5	12	1,5	0,95	50	4	655 046	45,75	
1	0,5	14	1,5	0,95	50	4	655 065	45,75	
1	0,5	16	1,5	0,95	50	4	655 066	45,75	
1,2	0,6	8	1,8	1,15	45	4	655 047	45,75	
1,2	0,6	12	1,8	1,15	45	4	655 048	45,75	
1,4	0,7	12	2,1	1,35	45	4	655 049	45,75	
1,5	0,75	8	2,3	1,45	45	4	655 050	45,75	
1,5	0,75	12	2,3	1,45	45	4	655 051	45,75	
1,5	0,75	16	2,3	1,45	50	4	655 052	45,75	
1,5	0,75	20	2,3	1,45	55	4	655 067	45,75	
1,6	0,8	16	2,4	1,55	50	4	655 053	45,75	
1,8	0,9	16	2,7	1,75	50	4	655 054	45,75	
2	1	6	3	1,95	45	4	655 068	45,75	
2	1	8	3	1,95	45	4	655 055	45,75	
2	1	10	3	1,95	45	4	655 069	45,75	
2	1	12	3	1,95	45	4	655 056	45,75	
2	1	14	3	1,95	50	4	655 070	45,75	
2	1	16	3	1,95	50	4	655 057	45,75	
2	1	20	3	1,95	55	4	655 058	45,75	
2	1	25	3	1,95	65	4	655 071	45,75	
2	1	30	3	1,95	70	4	655 072	45,75	
3	1,5	10	4,5	2,85	55	6	655 073	47,25	
3	1,5	16	4,5	2,85	55	6	655 059	47,25	
3	1,5	20	4,5	2,85	60	6	655 060	47,25	
3	1,5	25	4,5	2,85	65	6	655 074	47,25	
3	1,5	30	4,5	2,85	70	6	655 075	50,50	
3	1,5	35	4,5	2,85	80	6	655 076	50,50	
4	2	16	6	3,85	60	6	655 061	47,25	
4	2	20	6	3,85	65	6	655 062	47,25	
4	2	25	6	3,85	70	6	655 063	50,00	

**SELECT / MILL**  
 by WEXO®

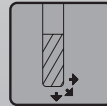
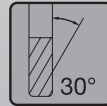
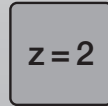

$d_1 = 0/-0,015$

$d_2 = h6$

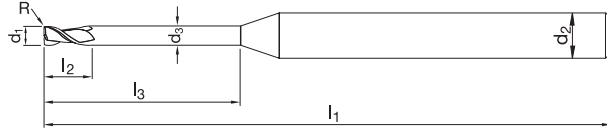

Katalog-Nr. W%		Catalogue no. W%					TL2LHTA-HM <sup>780</sup>			
Catalogue n° W%		Nr. di catalogo W%					TiAlN			
d <sub>1</sub> [mm]	R [mm]	l <sub>3</sub> [mm]	l <sub>2</sub> [mm]	d <sub>3</sub> [mm]	l <sub>1</sub> [mm]	d <sub>2</sub> [mm]	Code	€		
0,5	0,1	2	0,7	0,45	45	4	655 100	46,25		
0,5	0,1	4	0,7	0,45	45	4	655 101	46,25		
0,5	0,1	6	0,7	0,45	45	4	655 102	46,25		
0,6	0,1	4	0,9	0,55	45	4	655 104	46,25		
0,6	0,1	6	0,9	0,55	45	4	655 105	46,25		
0,7	0,1	4	1	0,65	45	4	655 107	46,25		
0,7	0,1	6	1	0,65	45	4	655 108	46,25		
0,8	0,1	4	1,2	0,75	45	4	655 109	46,25		
0,8	0,1	6	1,2	0,75	45	4	655 110	46,25		
0,8	0,1	8	1,2	0,75	45	4	655 111	46,25		
0,9	0,1	10	1,35	0,85	45	4	655 114	46,25		
1	0,2	6	1,5	0,95	45	4	655 115	46,25		
1	0,2	8	1,5	0,95	45	4	655 116	46,25		
1	0,2	10	1,5	0,95	45	4	655 117	46,25		
1	0,2	12	1,5	0,95	45	4	655 118	46,25		
1,2	0,2	6	1,8	1,15	45	4	655 119	46,25		
1,2	0,2	10	1,8	1,15	45	4	655 121	46,25		
1,2	0,2	12	1,8	1,15	45	4	655 122	46,25		
1,4	0,2	14	2,1	1,35	50	4	655 127	46,25		
1,5	0,2	6	2,3	1,45	45	4	655 129	46,25		
1,5	0,2	8	2,3	1,45	45	4	655 130	46,25		
1,5	0,2	12	2,3	1,45	45	4	655 132	46,25		
1,5	0,2	14	2,3	1,45	50	4	655 133	46,25		
1,5	0,2	16	2,3	1,45	50	4	655 134	46,25		
1,5	0,2	20	2,3	1,45	55	4	655 136	46,25		
2	0,2	6	3	1,95	45	4	655 169	46,25		
2	0,2	8	3	1,95	45	4	655 170	46,25		
2	0,2	10	3	1,95	45	4	655 171	46,25		
2	0,2	12	3	1,95	45	4	655 172	46,25		
2	0,2	14	3	1,95	50	4	655 173	46,25		
2	0,2	16	3	1,95	50	4	655 174	46,25		
2	0,2	18	3	1,95	55	4	655 175	46,25		
2	0,2	20	3	1,95	55	4	655 176	46,25		
2,5	0,2	12	3,7	2,45	45	4	655 179	46,25		
3	0,2	16	4,5	2,95	55	6	655 188	47,25		
3	0,2	20	4,5	2,95	60	6	655 190	47,25		

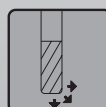
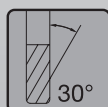
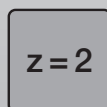
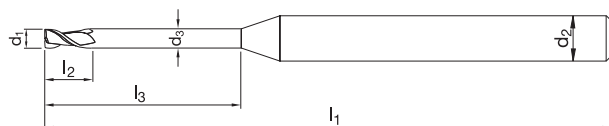

 $d_1 = 0/-0,015$ 
 $d_2 = h6$ 

Katalog-Nr. <sup>W%</sup> Catalogue n <sup>o</sup> W%		Catalogue no. <sup>W%</sup> Nr. di catalogo <sup>W%</sup>		SL2LHTA-HM <sup>780</sup>					
				TiAlN					
d <sub>1</sub> [mm]	l <sub>3</sub> [mm]	l <sub>2</sub> [mm]	d <sub>3</sub> [mm]	l <sub>1</sub> [mm]	d <sub>2</sub> [mm]	z	Code	€	
0,7	4	1	0,65	45	4	2	655 803	44,50	
0,7	6	1	0,65	45	4	2	655 804	44,50	
0,8	4	1,2	0,75	45	4	2	655 805	44,50	
0,8	6	1,2	0,75	45	4	2	655 806	44,50	
0,8	8	1,2	0,75	45	4	2	655 807	44,50	
1	6	1,5	0,97	45	4	2	655 808	44,50	
1	8	1,5	0,95	45	4	2	655 809	44,50	
1	10	1,5	0,95	45	4	2	655 810	44,50	
1	12	1,5	0,93	45	4	2	655 811	44,50	
1,2	6	2,3	1,47	45	4	2	655 812	44,50	
1,5	6	2,3	1,47	45	4	2	655 813	44,50	
1,5	8	2,3	1,45	45	4	2	655 814	44,50	
1,5	12	2,3	1,43	45	4	2	655 815	44,50	
1,5	14	2,3	1,43	45	4	2	655 816	44,50	
1,5	20	2,3	1,39	55	4	2	655 817	44,50	
2	6	3	1,97	45	4	2	655 818	44,50	
2	8	3	1,95	45	4	2	655 819	44,50	
2	10	3	1,95	45	4	2	655 820	44,50	
2	12	3	1,93	45	4	2	655 821	44,50	
2	16	3	1,91	50	4	2	655 822	44,50	
2	18	3	1,91	55	4	2	655 823	44,50	
2	20	3	1,89	55	4	2	655 824	44,50	
3	16	4,5	2,85	55	6	2	655 825	46,50	
3	20	4,5	2,85	60	6	2	655 826	46,50	

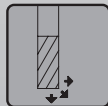
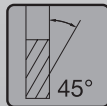
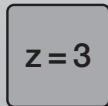
**SELECT / MILL**  
 by WEXO®

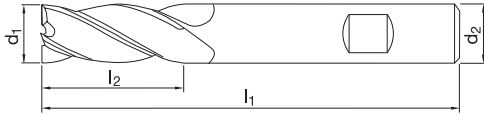

$d_1 = h10$      $d_2 = h6$



Katalog-Nr. W% Catalogue n° W%		Catalogue no. W% Nr. di catalogo W%			SK3TA-HM <sup>780</sup>		SL3TA-HM <sup>780</sup>		
					TiAIN		TiAIN		
d <sub>1</sub> [mm]	l <sub>2</sub> [mm]	l <sub>1</sub> [mm]	d <sub>2</sub> [mm]	z	Code	€	Code	€	
3	4	50	6	3	655 530	23,00			
4	5	54	6	3	655 532	25,25			
5	6	54	6	3	655 534	25,25			
6	7	54	6	3	655 535	24,75			
7	8	58	8	3	655 536	39,75			
8	9	58	8	3	655 537	38,75			
9	10	66	10	3	655 538	54,50			
10	11	66	10	3	655 539	51,00			
12	12	73	12	3	655 540	70,50			
14	14	75	14	3	655 541	89,50			
16	16	82	16	3	655 542	122,00			
18	18	84	18	3	655 543	152,00			
20	20	92	20	3	655 544	189,00			
3	7	57	6	3			655 550	25,00	
3,5	7	57	6	3			655 551	28,00	
4	8	57	6	3			655 552	27,50	
4,5	8	57	6	3			655 553	27,50	
5	10	57	6	3			655 554	27,25	
6	10	57	6	3			655 555	25,00	
7	13	63	8	3			655 556	40,75	
8	16	63	8	3			655 557	40,25	
9	16	72	10	3			655 558	60,00	
10	19	72	10	3			655 559	57,00	
12	22	83	12	3			655 560	80,50	
14	22	92	14	3			655 561	102,00	
16	26	92	16	3			655 562	139,00	
18	26	92	18	3			655 563	173,00	
20	32	104	20	3			655 564	210,00	
<b>Satz, Set, Kit, Serie    Ø 6 – 8 – 10 – 12 mm</b>								655 996	185,00

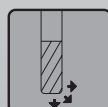
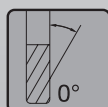
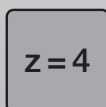

$d_1 = 0/-0,02$      $d_2 = h6$      $R = \pm 0,005$

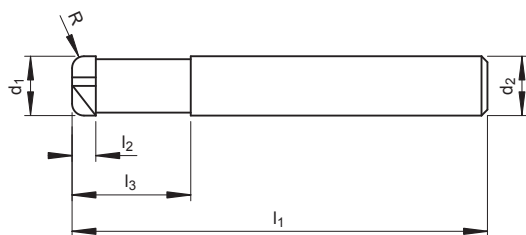

Katalog-Nr. <sup>W%</sup> Catalogue n° <sup>W%</sup>		Catalogue no. <sup>W%</sup> Nr. di catalogo <sup>W%</sup>		TN4HFTA-HM <sup>780</sup>		TL4HFTA-HM <sup>780</sup>	
				TiAlN+		TiAlN+	
$d_1$ [mm]	R [mm]	$l_3$ [mm]	$l_2$ [mm]	$l_1$ [mm]	$d_2$ [mm]	Code	€
2	0,5	6	1	50	6	656 000	66,50
3	0,5	8	1,2	50	6	656 001	66,50
4	0,5	10	1,5	50	6	656 002	66,50
6	0,5	12	2,5	60	6	656 003	66,50
6	1	12	2,5	60	6	656 004	66,50
8	1	16	3,5	60	8	656 005	86,00
8	2	16	3,5	60	8	656 006	86,00
10	1	20	4	70	10	656 007	128,00
10	2	20	4	70	10	656 008	128,00
12	2	25	5	80	12	656 009	178,00
12	3	25	5	80	12	656 010	178,00
2	0,5	6	1	70	6		656 020 72,50
3	0,5	8	1,2	70	6		656 021 72,50
4	0,5	10	1,5	70	6		656 022 72,50
5	0,5	10	2	70	6		656 023 72,50
6	0,5	12	2,5	90	6		656 024 79,00
6	1	12	2,5	90	6		656 025 79,00
8	1	16	3,5	100	8		656 026 100,00
8	2	16	3,5	100	8		656 027 100,00
10	1	20	4	100	10		656 028 141,00
10	2	20	4	100	10		656 029 141,00
12	2	25	5	110	12		656 030 197,00
12	3	25	5	110	12		656 031 197,00

**SELECT / MILL**  
by WEXO<sup>®</sup>



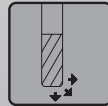
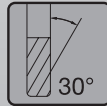
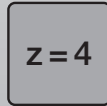

$d_1 = e8$

$d_2 = h6$

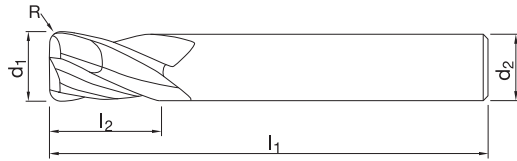

Katalog-Nr. W%		Catalogue no. W%			TN4TA-HM <sup>780</sup>			
Catalogue n° W%		Nr. di catalogo W%			TiAIN			
d <sub>1</sub> [mm]	R [mm]	l <sub>2</sub> [mm]	l <sub>1</sub> [mm]	d <sub>2</sub> [mm]	Code	€		
4	0,5	11	50	4	655 402	38,75		
4	1	11	50	4	655 403	38,75		
6	0,5	16	50	6	655 404	46,50		
6	1	16	50	6	655 405	46,50		
6	1,5	16	50	6	655 406	46,50		
6	2	16	50	6	655 407	46,50		
8	0,5	19	60	8	655 408	56,00		
8	1	19	60	8	655 409	56,00		
8	1,5	19	60	8	655 410	56,00		
8	2	19	60	8	655 411	56,00		
10	0,5	22	75	10	655 414	74,50		
10	1	22	75	10	655 415	74,50		
10	1,5	22	75	10	655 416	74,50		
10	2	22	75	10	655 417	74,50		
12	1	26	75	12	655 421	105,00		
12	1,5	26	75	12	655 422	105,00		
12	2	26	75	12	655 423	105,00		
12	3	26	75	12	655 425	105,00		
16	1	32	75	16	655 427	163,00		
16	2	32	75	16	655 429	163,00		
16	3	32	75	16	655 431	163,00		



$d_1 = h10$

$d_2 = h6$

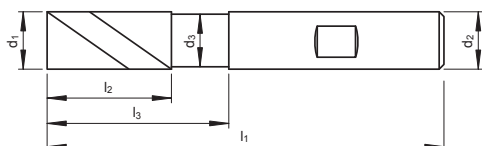

Katalog-Nr. <sup>W%</sup> Catalogue n <sup>o</sup> W%		Catalogue no. <sup>W%</sup> Nr. di catalogo <sup>W%</sup>						SK4UGTA-HM <sup>780</sup>		SL4UGTA-HM <sup>780</sup>	
								TiAlN		TiAlN	
$d_1$ [mm]	$l_2$ [mm]	$l_3$ [mm]	$d_3$ [mm]	$l_1$ [mm]	$d_2$ [mm]	z	Code	€	Code	€	
6	7	18	5,5	54	6	4	655 300	27,50			
8	9	22	7,5	58	8	4	655 301	36,00			
10	11	26	9,2	66	10	4	655 302	46,50			
12	12	28	11,2	73	12	4	655 303	74,00			
14	14	30	13,2	75	14	4	655 304	96,00			
16	16	34	15	82	16	4	655 305	116,00			
20	20	42	19	92	20	4	655 307	177,00			
4	11	18	3,7	57	6	4			655 200	30,25	
5	13	18	4,7	57	6	4			655 201	30,25	
6	13	21	5,5	57	6	4			655 202	30,25	
8	19	27	7,5	63	8	4			655 203	39,00	
10	22	32	9,2	72	10	4			655 204	51,50	
12	26	38	11,2	83	12	4			655 205	81,00	
14	26	38	13,2	83	14	4			655 206	105,00	
16	32	44	15	92	16	4			655 207	127,00	
20	38	54	19	104	20	4			655 209	200,00	
Satz, Set, Kit, Serie		Ø 6 - 8 - 10 - 12 - 16 mm						655 993	268,00	655 992	296,00



**SELECT // MILL**  
 by WEXO<sup>®</sup>

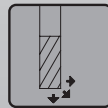
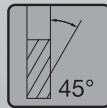
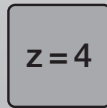

$d_1 = h10$      $d_2 = h6$

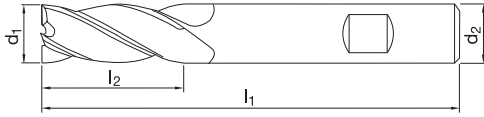

Katalog-Nr. W%		Catalogue no. W%			SL4HRTA-HM <sup>780</sup>			
Catalogue n° W%		Nr. di catalogo W%			TiAIN			
d <sub>1</sub> [mm]	l <sub>2</sub> [mm]	l <sub>1</sub> [mm]	d <sub>2</sub> [mm]	z	Code	€		
4	11	57	6	4	655 608	35,50		
5	13	57	6	4	655 609	35,50		
6	13	57	6	4	655 610	35,50		
8	19	63	8	4	655 611	45,75		
10	22	72	10	4	655 612	60,00		
12	26	83	12	4	655 613	96,50		
16	32	92	16	4	655 614	149,00		
20	38	104	20	4	655 615	234,00		
Satz, Set, Kit, Serie		Ø 6 - 8 - 10 - 12 - 16 mm			655 994	324,00		



by WEXO<sup>®</sup>  
**SELECT | MILL**

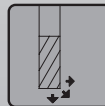
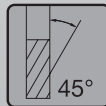
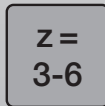

$d_1 = h10$   
 $d_2 = h6$

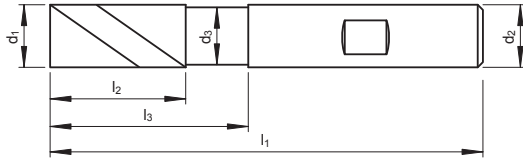

Katalog-Nr. <sup>W%</sup> Catalogue n <sup>o</sup> W%		Catalogue no. <sup>W%</sup> Nr. di catalogo <sup>W%</sup>		SLHRTA-HM <sup>780</sup>			
				TiAlN			
d <sub>1</sub> [mm]	l <sub>2</sub> [mm]	l <sub>3</sub> [mm]	d <sub>3</sub> [mm]	l <sub>1</sub> [mm]	d <sub>2</sub> [mm]	z	Code €
4	11	-	-	57	6	3	655 600 50,50
5	13	-	-	57	6	4	655 601 50,50
6	16	-	-	57	6	4	655 602 50,50
8	19	-	-	63	8	4	655 603 65,00
10	22	-	-	72	10	4	655 604 75,00
12	26	38	11,4	83	12	4	655 605 89,50
16	32	44	15,4	92	16	5	655 606 152,00
20	38	54	19,4	104	20	6	655 607 236,00
Satz, Set, Kit, Serie		Ø 6 - 8 - 10 - 12 - 16 mm		655 991	352,00		



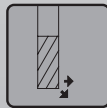
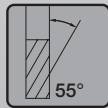
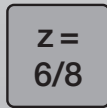

$d_1 = h10$

$d_2 = h6$

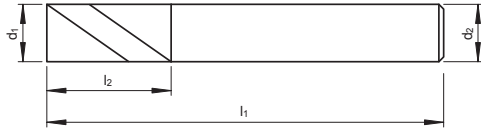

Katalog-Nr. W%		Catalogue no. W%		SKMZTA-HM <sup>780</sup>			
Catalogue n° W%		Nr. di catalogo W%		TiAlN			
d <sub>1</sub> [mm]	l <sub>2</sub> [mm]	l <sub>1</sub> [mm]	d <sub>2</sub> [mm]	z	Code	€	
3	8	57	6	6	655 630	42,00	
4	11	57	6	6	655 631	44,00	
5	13	57	6	6	655 632	46,25	
6	13	57	6	6	655 633	43,50	
8	19	63	8	6	655 634	59,00	
10	22	72	10	6	655 635	77,50	
12	26	83	12	6	655 636	110,00	
14	26	83	14	6	655 637	148,00	
16	32	92	16	6	655 638	183,00	
18	32	92	18	8	655 639	238,00	
20	38	104	20	8	655 640	320,00	



**E90TA-HM**



MAT	1.1-1.4; 2.1-2.4 HRC < 20	1.3-1.5; 2.1-2.4 HRC 20-30	1.3-1.5 HRC 30-38	1.3-1.5 HRC 38-45	1.3-1.5 < HRC 55	1.6 < HRC 25						
<b>Seitenfräsen · Side milling · Contournage · Contornatura</b>												
d <sub>1</sub> [mm]	n [min <sup>-1</sup> ]	v <sub>f</sub> [mm/min]	n [min <sup>-1</sup> ]	v <sub>f</sub> [mm/min]	n [min <sup>-1</sup> ]	v <sub>f</sub> [mm/min]	n [min <sup>-1</sup> ]	v <sub>f</sub> [mm/min]	n [min <sup>-1</sup> ]	v <sub>f</sub> [mm/min]	n [min <sup>-1</sup> ]	v <sub>f</sub> [mm/min]
4,0	11.150	4.460	9.550	3.820	7.960	2.390	6.370	2.550	4.380	1.750	5.570	2.230
6,0	7.430	3.570	6.370	3.060	5.310	1.910	4.250	2.040	2.920	1.400	3.720	1.790
8,0	5.570	3.900	4.780	3.350	3.980	1.670	3.180	2.230	2.190	1.530	2.790	1.950
10,0	4.460	4.280	3.820	3.670	3.180	1.530	2.550	2.450	1.750	1.680	2.230	2.140
12,0	3.720	4.020	3.180	3.430	2.650	1.430	2.120	2.290	1.460	1.580	1.860	2.010
16,0	2.790	3.350	2.390	2.870	1.990	1.190	1.590	1.910	1.090	1.310	1.390	1.670

**RK2TA-HM / RN2TA-HM**



$$d_{\text{eff}} = 2 \cdot \sqrt{d_1 \cdot a_p - a_p^2}$$

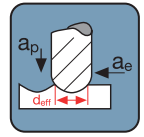

MAT	2.1-2.4	1.1-1.2 HRC <20	1.3-1.5 HRC <30	1.3-1.5 HRC 30-45	1.6 HRC 25	1.5 HRC 45-55	1.5 HRC 55-60	5 HRC <45
-----	---------	--------------------	--------------------	----------------------	---------------	------------------	------------------	--------------

**Zeilenfräsen · Profil milling · Balayage · Fresatura trasversale**

d <sub>1</sub> [mm]	n [min <sup>-1</sup> ]	v <sub>f</sub> [mm/min]	n [min <sup>-1</sup> ]	v <sub>f</sub> [mm/min]	n [min <sup>-1</sup> ]	v <sub>f</sub> [mm/min]	n [min <sup>-1</sup> ]	v <sub>f</sub> [mm/min]	n [min <sup>-1</sup> ]	v <sub>f</sub> [mm/min]	n [min <sup>-1</sup> ]	v <sub>f</sub> [mm/min]	n [min <sup>-1</sup> ]	v <sub>f</sub> [mm/min]	n [min <sup>-1</sup> ]	v <sub>f</sub> [mm/min]
1,0	32.000	685	32.000	685	25.470	545	17.830	290	17.830	270	15.190	225	11.690	110	15.190	165
2,0	20.380	820	16.980	680	12.740	510	8.920	270	8.920	290	7.600	210	5.850	120	7.600	190
3,0	13.590	820	11.320	680	8.490	510	5.950	270	5.950	290	5.070	210	3.900	120	5.070	190
4,0	10.190	820	8.490	680	6.370	510	4.460	270	4.460	290	3.800	210	2.930	150	3.800	210
5,0	8.150	815	6.800	680	5.100	510	3.570	270	3.570	290	3.040	210	2.340	145	3.040	235
6,0	6.800	865	5.660	720	4.250	540	2.980	285	2.980	305	2.540	225	1.950	155	2.540	245
8,0	5.100	1.075	4.250	895	3.190	670	2.230	355	2.230	375	1.900	275	1.470	180	1.900	275
10,0	4.080	980	3.400	820	2.550	615	1.790	325	1.790	345	1.520	255	1.170	175	1.520	280
12,0	3.400	910	2.830	755	2.130	570	1.490	300	1.490	340	1.270	235	980	165	1.270	260
Ø d <sub>1</sub>	1,0 ~ 12,0											1,0 ~ 12,0				
a <sub>p</sub>	0,1 x d <sub>1</sub>											0,05 x d <sub>1</sub>				
a <sub>e</sub>	0,2 x d <sub>1</sub>											0,1 x d <sub>1</sub>				

MAT	2.1-2.4	1.1-1.2 HRC <20	1.3-1.5 HRC <30	1.3-1.5 HRC 30-45	1.6 HRC 25	1.5 HRC 45-55	1.5 HRC 55-60	5 HRC <45
-----	---------	--------------------	--------------------	----------------------	---------------	------------------	------------------	--------------

**HSM-Schrupfräsen · HSM-Roughing · Ebauchage en UGV · Sgrossatura - Alta velocita'**

d <sub>1</sub> [mm]	n [min <sup>-1</sup> ]	v <sub>f</sub> [mm/min]	n [min <sup>-1</sup> ]	v <sub>f</sub> [mm/min]	n [min <sup>-1</sup> ]	v <sub>f</sub> [mm/min]	n [min <sup>-1</sup> ]	v <sub>f</sub> [mm/min]	n [min <sup>-1</sup> ]	v <sub>f</sub> [mm/min]	n [min <sup>-1</sup> ]	v <sub>f</sub> [mm/min]	n [min <sup>-1</sup> ]	v <sub>f</sub> [mm/min]	n [min <sup>-1</sup> ]	v <sub>f</sub> [mm/min]
1,0	32.000	1.175	32.000	1.175	32.000	1.175	32.000	1.175	32.000	1.175	32.000	1.205	32.000	1.055	32.000	1.205
2,0	32.000	2.205	32.000	2.205	32.000	2.205	32.000	2.205	32.000	2.205	32.000	2.255	32.000	1.970	32.000	2.255
3,0	32.000	2.940	32.000	2.940	32.000	2.940	32.000	2.940	32.000	2.940	32.000	3.005	24.880	2.045	32.000	3.005
4,0	32.000	3.305	32.000	3.305	32.000	3.305	29.220	3.020	29.220	3.020	27.990	2.955	18.660	1.725	27.990	2.955
5,0	32.000	3.675	32.000	3.675	29.220	3.355	23.370	2.685	23.370	2.685	22.400	2.630	14.930	1.535	22.400	2.630
6,0	29.220	4.025	26.780	3.690	24.350	3.355	19.480	2.685	19.480	2.685	18.660	2.630	12.440	1.535	18.660	2.630
8,0	21.910	3.520	20.090	3.230	18.260	2.935	14.610	2.350	14.610	2.350	14.000	2.300	9.330	1.340	14.000	2.300
10,0	17.530	3.220	16.070	2.950	14.610	2.685	11.690	2.150	11.690	2.150	11.200	2.105	7.470	1.230	11.200	2.105
12,0	14.610	3.355	13.390	3.075	12.180	2.795	9.740	2.235	9.740	2.235	9.330	2.190	6.220	1.280	9.330	2.190
Ø d <sub>1</sub>	1,0 ~ 12,0											1,0 ~ 12,0				
a <sub>p</sub>	0,05 x d <sub>1</sub>											0,03 x d <sub>1</sub>				
a <sub>e</sub>	0,2 x d <sub>1</sub>											0,1 x d <sub>1</sub>				

MAT	2.1-2.4	1.1-1.2 HRC <20	1.3-1.5 HRC <30	1.3-1.5 HRC 30-45	1.6 HRC 25	1.5 HRC 45-55	1.5 HRC 55-60	5 HRC <45
-----	---------	--------------------	--------------------	----------------------	---------------	------------------	------------------	--------------

**HSM-Schlichtfräsen · HSM-Finishing · Finissage en UGV · Finitura - Alta velocita'**

d <sub>1</sub> [mm]	n [min <sup>-1</sup> ]	v <sub>f</sub> [mm/min]	n [min <sup>-1</sup> ]	v <sub>f</sub> [mm/min]	n [min <sup>-1</sup> ]	v <sub>f</sub> [mm/min]	n [min <sup>-1</sup> ]	v <sub>f</sub> [mm/min]	n [min <sup>-1</sup> ]	v <sub>f</sub> [mm/min]	n [min <sup>-1</sup> ]	v <sub>f</sub> [mm/min]	n [min <sup>-1</sup> ]	v <sub>f</sub> [mm/min]	n [min <sup>-1</sup> ]	v <sub>f</sub> [mm/min]
1,0	32.000	1.600	32.000	1.600	32.000	1.600	32.000	1.600	32.000	1.600	32.000	1.600	32.000	1.600	32.000	1.600
2,0	32.000	2.560	32.000	2.560	32.000	2.560	32.000	2.560	32.000	2.560	32.000	2.560	32.000	2.560	32.000	2.560
3,0	32.000	2.880	32.000	2.880	32.000	2.880	32.000	2.880	32.000	2.880	32.000	2.880	32.000	2.880	32.000	2.880
4,0	32.000	3.075	32.000	3.075	32.000	3.075	32.000	3.075	32.000	3.075	32.000	3.075	32.000	3.075	32.000	3.075
5,0	32.000	3.200	32.000	3.200	32.000	3.200	32.000	3.200	32.000	3.200	32.000	3.200	32.000	3.200	32.000	3.200
6,0	32.000	3.840	32.000	3.840	32.000	3.840	32.000	3.840	32.000	3.840	32.000	3.840	32.000	3.840	32.000	3.840
8,0	32.000	4.610	32.000	4.610	32.000	4.610	32.000	4.610	32.000	4.610	32.000	4.610	26.190	3.775	32.000	4.610
10,0	32.000	5.120	32.000	5.120	32.000	5.120	32.000	5.120	32.000	5.120	31.430	5.030	20.950	3.355	31.430	5.030
12,0	32.000	6.145	32.000	6.145	32.000	6.145	32.000	6.145	32.000	6.145	26.190	5.030	17.460	3.355	26.190	5.030
Ø d <sub>1</sub>	<4,0								4,0 ~ 12,0							
a <sub>p</sub>	0,02 x d <sub>1</sub>								0,02 x d <sub>1</sub>							
a <sub>e</sub>	0,02 x d <sub>1</sub>								0,01 x d <sub>1</sub>							

Korrekturfaktoren · Correction factors · Facteurs de correction · Fattori di correzione			
Typ · Type · Tipo		RK2TA-HM	RN2TA-HM
Faktor · Factor · Facteur · Fattore	n & v <sub>f</sub>	x 1,20	x 1,00
			RL2TA-HM
			x 0,70

**RL2LHTA-HM**

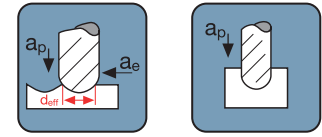

$$d_{eff} = 2 \cdot \sqrt{d_1 \cdot a_p - a_p^2}$$

MAT	1.1-1.4; 2.1-2.4 HRC 20-30	1.3-1.5 HRC 30-45	1.3-1.5 HRC 45-55	1.3-1.5 HRC 55-60
<b>Zeilenfräsen · Profil milling · Balayage · Fresatura trasversale</b>				
d <sub>1</sub> [mm]	n [min <sup>-1</sup> ]	v <sub>f</sub> [mm/min]	n [min <sup>-1</sup> ]	v <sub>f</sub> [mm/min]
0,5	28.000	375	28.000	230
0,6	28.000	450	28.000	275
0,8	28.000	525	23.880	275
1,0	25.470	545	19.100	290
1,2	21.230	510	15.920	270
1,4	18.190	490	13.650	255
1,5	16.980	500	12.740	265
1,6	15.920	510	11.940	270
1,8	14.150	495	10.620	260
2,0	12.740	510	9.550	270
3,0	8.490	510	6.370	270
4,0	6.370	510	4.780	255
Ø d <sub>1</sub>	0,5 ~ 4,0		0,5 ~ 4,0	
a <sub>p</sub>	0,1 x d <sub>1</sub>		0,05 x d <sub>1</sub>	
a <sub>e</sub>	0,2 x d <sub>1</sub>		0,1 x d <sub>1</sub>	

Korrekturfaktoren · Correction factors ·  
Facteurs de correction · Fattori di correzione:

l<sub>3</sub>/d<sub>1</sub> > 5:  
v<sub>f</sub> = 70%  
n = 80%

MAT	1.1-1.4; 2.1-2.4 HRC 20-30	1.3-1.5 HRC 30-45	1.3-1.5 HRC 45-55	1.3-1.5 HRC 55-60	1.1-1.4; 2.1-2.4 HRC 20-30	1.3-1.5 HRC 30-45	1.3-1.5 HRC 45-55	1.3-1.5 HRC 55-60
<b>HSM-Schruppfäsen · HSM-Roughing · Ebauchage en UGV · Sgrossatura - Alta velocita'</b>					<b>HSM-Schlichtfräsen · HSM-Finishing · Finissage en UGV · Finitura - Alta velocita'</b>			
d <sub>1</sub> [mm]	n [min <sup>-1</sup> ]	v <sub>f</sub> [mm/min]	n [min <sup>-1</sup> ]	v <sub>f</sub> [mm/min]	n [min <sup>-1</sup> ]	v <sub>f</sub> [mm/min]	n [min <sup>-1</sup> ]	v <sub>f</sub> [mm/min]
0,5	32.000	735	32.000	735	32.000	940	32.000	940
0,6	32.000	885	32.000	885	32.000	1.130	32.000	1.130
0,8	32.000	1.030	32.000	1.030	32.000	1.315	32.000	1.315
1,0	32.000	1.175	32.000	1.175	32.000	1.505	32.000	1.505
1,2	32.000	1.325	32.000	1.325	32.000	1.690	32.000	1.690
1,4	32.000	1.470	32.000	1.470	32.000	1.880	31.990	1.880
1,5	32.000	1.620	32.000	1.620	32.000	2.065	29.860	1.930
1,6	32.000	1.765	32.000	1.765	32.000	2.255	27.990	1.970
1,8	32.000	1.910	32.000	1.910	32.000	2.440	24.880	1.900
2,0	32.000	2.205	32.000	2.205	32.000	2.815	22.400	1.970
3,0	32.000	2.940	26.290	2.415	22.400	2.630	14.930	1.755
4,0	26.290	2.715	19.720	2.040	16.800	2.220	11.200	1.480
Ø d <sub>1</sub>	0,5 ~ 4,0		0,5 ~ 4,0		0,5 ~ 4,0			
a <sub>p</sub>	0,05 x d <sub>1</sub>		0,03 x d <sub>1</sub>		0,015 x d <sub>1</sub>			
a <sub>e</sub>	0,2 x d <sub>1</sub>		0,1 x d <sub>1</sub>		0,02 x d <sub>1</sub>			

MAT	1.1-1.4; 2.1-2.4 HRC 20-30	1.3-1.5 HRC 30-45	1.3-1.5 HRC 45-55	1.3-1.5 HRC 55-60	1.1-1.4; 2.1-2.4 HRC 20-30	1.3-1.5 HRC 30-45	1.3-1.5 HRC 45-55	1.3-1.5 HRC 55-60
<b>Nutenfräsen · Slotting · Rainurage · Cave</b>					<b>HSM-Nutenfräsen · HSM-Slotting · Rainurage en UGV · Cave - Alta velocita'</b>			
d <sub>1</sub> [mm]	n [min <sup>-1</sup> ]	v <sub>f</sub> [mm/min]	n [min <sup>-1</sup> ]	v <sub>f</sub> [mm/min]	n [min <sup>-1</sup> ]	v <sub>f</sub> [mm/min]	n [min <sup>-1</sup> ]	v <sub>f</sub> [mm/min]
0,5	25.600	225	25.600	195	20.000	100	18.000	50
0,6	25.470	260	22.920	200	20.000	120	16.980	50
0,8	21.490	305	19.340	240	17.190	185	12.740	70
1,0	19.100	310	17.190	245	15.280	185	10.190	85
1,2	15.920	310	14.330	245	12.740	185	8.490	85
1,4	13.650	310	12.280	245	10.920	185	7.280	85
1,5	12.740	310	11.460	245	10.190	185	6.800	85
1,6	11.940	310	10.750	245	9.550	185	6.370	85
1,8	10.620	310	9.550	245	8.490	185	5.660	85
2,0	9.550	345	8.600	280	7.640	185	5.100	85
3,0	6.370	345	5.730	280	5.100	185	3.400	85
4,0	4.780	345	4.300	285	3.820	185	2.550	80
Ø d <sub>1</sub>	0,5 ~ 4,0		0,5 ~ 4,0		0,5 ~ 4,0		0,5 ~ 4,0	
a <sub>p</sub>	0,1 x d <sub>1</sub>		0,02 x d <sub>1</sub>		0,025 x d <sub>1</sub>		0,020 x d <sub>1</sub>	
a <sub>e</sub>	d <sub>1</sub>		d <sub>1</sub>		d <sub>1</sub>		d <sub>1</sub>	

**TL2LHTA-HM**

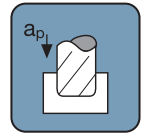

MAT	1.1-1.4; 2.1-2.4 HRC 20-30			1.3-1.5 HRC 30-45		1.3-1.5 HRC 45-55		1.3-1.5 HRC 55-60	
<b>Nutenfräsen · Slotting · Rainurage · Cave</b>									
d <sub>1</sub> [mm]	n [min <sup>-1</sup> ]	v <sub>f</sub> [mm/min]	n [min <sup>-1</sup> ]	v <sub>f</sub> [mm/min]	n [min <sup>-1</sup> ]	v <sub>f</sub> [mm/min]	n [min <sup>-1</sup> ]	v <sub>f</sub> [mm/min]	
0,5	32.000	195	25.500	105	15.000	60	10.200	45	
0,6	30.000	240	21.200	130	12.800	80	8.500	35	
0,7	25.500	255	18.200	150	10.900	70	7.300	30	
0,8	22.500	270	16.000	160	9.600	80	6.400	40	
0,9	20.000	320	14.200	200	8.500	85	5.700	35	
1,0	18.000	360	12.800	205	7.650	95	5.100	45	
1,2	15.000	360	10.600	215	6.400	90	4.250	45	
1,4	12.800	360	9.100	205	5.500	90	3.650	45	
1,5	12.000	360	8.500	205	5.100	95	3.400	45	
2,0	9.000	360	6.400	205	3.800	95	2.550	45	
2,5	7.200	360	5.100	205	3.100	95	2.050	45	
3,0	6.000	360	4.250	205	2.550	95	1.700	45	
∅ d <sub>1</sub>	<1,0			1,0 ~ 3,0		0,5 ~ 3,0		0,5 ~ 3,0	
a <sub>p</sub>	0,02 ~ 0,05 x d <sub>1</sub>			0,05 ~ 0,1 x d <sub>1</sub>		0,01 ~ 0,02 x d <sub>1</sub>		0,01 x d <sub>1</sub>	
a <sub>e</sub>	d <sub>1</sub>								
MAT	1.1-1.4; 2.1-2.4 HRC 20-30			1.3-1.5 HRC 30-45		1.3-1.5 HRC 45-55		1.3-1.5 HRC 55-60	
<b>HSM-Nutenfräsen · HSM-Slotting · Rainurage en UGV · Cave – Alta velocità</b>									
d <sub>1</sub> [mm]	n [min <sup>-1</sup> ]	v <sub>f</sub> [mm/min]	n [min <sup>-1</sup> ]	v <sub>f</sub> [mm/min]	n [min <sup>-1</sup> ]	v <sub>f</sub> [mm/min]	n [min <sup>-1</sup> ]	v <sub>f</sub> [mm/min]	
0,5	32.000	260	32.000	205	32.000	155	32.000	105	
0,6	32.000	385	32.000	310	32.000	235	32.000	155	
0,7	32.000	495	32.000	395	32.000	300	32.000	200	
0,8	32.000	670	32.000	535	32.000	400	31.840	265	
0,9	32.000	810	32.000	650	32.000	485	28.300	290	
1,0	32.000	1.025	32.000	820	32.000	615	25.470	330	
1,2	32.000	1.230	32.000	985	31.840	735	21.230	330	
1,4	32.000	1.435	32.000	1.150	27.290	735	18.190	330	
1,5	32.000	1.540	32.000	1.230	25.470	735	16.980	330	
2,0	31.840	2.040	25.470	1.305	19.100	735	12.740	330	
2,5	25.470	2.040	20.380	1.305	15.280	735	10.190	330	
3,0	21.230	2.040	16.980	1.305	12.740	735	8.490	330	
∅ d <sub>1</sub>	0,5 ~ 3,0				0,5 ~ 3,0		0,5 ~ 3,0		
a <sub>p</sub>	0,02 ~ 0,03 x d <sub>1</sub>				0,01 ~ 0,015 x d <sub>1</sub>		0,01 x d <sub>1</sub>		
a <sub>e</sub>	d <sub>1</sub>								

**SL2LHTA-HM**

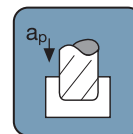

MAT	1.4/1.5 HRC 20-30	1.4/1.5 HRC 30-45	1.4/1.5 HRC 50-55	1.4/1.5 HRC 55-60	2					
<b>Nutenfräsen · Slotting · Rainurage · Cave</b>										
d <sub>1</sub> [mm]	n [min <sup>-1</sup> ]	v <sub>f</sub> [mm/min]	n [min <sup>-1</sup> ]	v <sub>f</sub> [mm/min]	n [min <sup>-1</sup> ]	v <sub>f</sub> [mm/min]	n [min <sup>-1</sup> ]	v <sub>f</sub> [mm/min]	n [min <sup>-1</sup> ]	v <sub>f</sub> [mm/min]
0,7	42.000	2.060	42.000	2.060	42.000	2.060	42.000	2.060	42.000	2.060
0,8	42.000	2.355	42.000	2.355	42.000	2.355	39.790	2.230	42.000	2.355
0,9	42.000	2.650	42.000	2.650	42.000	2.650	35.370	2.230	42.000	2.650
1,0	42.000	3.780	42.000	3.780	42.000	3.780	31.840	2.870	42.000	3.780
2,0	39.790	7.165	31.840	5.735	23.880	4.300	15.920	2.870	39.790	7.165
3,0	26.530	7.960	21.230	6.370	15.920	4.780	10.620	3.190	26.530	7.960
Ø d <sub>1</sub>	0,7 ~ 3,0				0,7 ~ 3,0					
a <sub>p</sub>	0,25 x d <sub>1</sub>	0,20 x d <sub>1</sub>	0,015 x d <sub>1</sub>	0,01 x d <sub>1</sub>	0,025 x d <sub>1</sub>					



**SK3TA-HM + SL3TA-HM**



MAT	1.1-1.4; 2.1-2.4 HRC < 20	1.3-1.5; 2.1-2.4 HRC 20-30	1.3-1.5 HRC 30-38	1.3-1.5 HRC 38-45	1.3-1.5 < HRC 55	1.6 < HRC 25
<b>Seitenfräsen · Side milling · Contournage · Contornatura</b>						
d <sub>1</sub> [mm]	n [min <sup>-1</sup> ]	v <sub>f</sub> [mm/min]	n [min <sup>-1</sup> ]	v <sub>f</sub> [mm/min]	n [min <sup>-1</sup> ]	v <sub>f</sub> [mm/min]
3,0	18.050	1.030	16.990	970	16.990	970
3,5	15.470	1.020	14.560	960	14.560	960
4,0	13.540	1.020	12.740	960	12.740	960
4,5	12.030	970	11.320	920	11.320	920
5,0	10.830	910	10.190	860	10.190	860
6,0	9.020	1.060	8.490	990	8.490	990
7,0	7.730	1.070	7.280	1.000	7.280	1.000
8,0	6.770	1.080	6.370	1.010	6.370	1.010
9,0	6.020	1.070	5.660	1.000	5.660	1.000
10,0	5.410	1.040	5.100	980	5.100	980
12,0	4.510	1.070	4.250	1.010	4.250	1.010
14,0	3.870	1.010	3.640	950	3.640	950
16,0	3.380	960	3.180	910	3.180	910
18,0	3.010	920	2.830	870	2.830	870
20,0	2.710	890	2.550	840	2.550	840
a <sub>p</sub>	1,0 x d <sub>1</sub>					
a <sub>e</sub>	0,5 x d <sub>1</sub>					
MAT	1.1-1.4; 2.1-2.4 HRC < 20	1.3-1.5; 2.1-2.4 HRC 20-30	1.3-1.5 HRC 30-38	1.3-1.5 HRC 38-45	1.3-1.5 < HRC 55	1.6 < HRC 25
<b>Nutenfräsen · Slotting · Rainurage · Cave</b>						
d <sub>1</sub> [mm]	n [min <sup>-1</sup> ]	v <sub>f</sub> [mm/min]	n [min <sup>-1</sup> ]	v <sub>f</sub> [mm/min]	n [min <sup>-1</sup> ]	v <sub>f</sub> [mm/min]
3,0	10.080	300	9.550	290	9.340	200
3,5	8.640	340	8.190	320	8.010	190
4,0	7.560	340	7.170	320	7.010	210
4,5	6.720	340	6.370	320	6.230	220
5,0	6.050	360	5.730	340	5.610	240
6,0	5.040	360	4.780	340	4.670	240
7,0	4.320	360	4.090	340	4.000	240
8,0	3.780	360	3.580	340	3.500	250
9,0	3.360	350	3.180	330	3.110	250
10,0	3.030	350	2.870	330	2.800	250
12,0	2.520	350	2.390	330	2.340	250
14,0	2.160	320	2.050	310	2.000	240
16,0	1.890	310	1.790	290	1.750	240
18,0	1.680	300	1.590	290	1.560	230
20,0	1.510	300	1.430	280	1.400	240
a <sub>p</sub>	0,5 x d <sub>1</sub>					
a <sub>e</sub>	1,0 x d <sub>1</sub>					

**TN4HFTA-HM + TL4HFTA-HM**

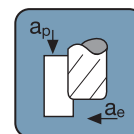

MAT	1.4-1.5									
	HRC < 40		HRC 40 ~ 49		HRC 50 ~ 54		HRC 55 ~ 59		HRC 60 ~ 65	
d <sub>1</sub> [mm]	n [min <sup>-1</sup> ]	v <sub>f</sub> [mm/min]	n [min <sup>-1</sup> ]	v <sub>f</sub> [mm/min]	n [min <sup>-1</sup> ]	v <sub>f</sub> [mm/min]	n [min <sup>-1</sup> ]	v <sub>f</sub> [mm/min]	n [min <sup>-1</sup> ]	v <sub>f</sub> [mm/min]
2	13.500	6.500	9.550	3.800	5.500	2.200	3.200	1.000	2.200	550
3	9.550	6.500	6.900	4.150	4.550	2.750	2.850	1.150	1.900	610
4	7.950	7.000	5.750	4.600	4.000	3.200	2.550	1.350	1.750	700
5	6.500	7.300	4.800	4.800	3.400	3.500	2.200	1.600	1.500	700
6	5.800	7.650	4.100	4.900	2.900	3.500	1.850	1.850	1.350	795
8	4.350	7.650	3.050	4.900	2.200	3.500	1.400	1.850	995	795
10	3.500	7.650	2.450	4.900	1.750	3.500	1.100	1.850	795	795
12	2.900	7.650	2.050	4.900	1.450	3.500	925	1.850	665	795
a <sub>p</sub>	0,2 x R					0,1 x R				
a <sub>e</sub>	0,5 x d <sub>1</sub>					0,5 x d <sub>1</sub>				

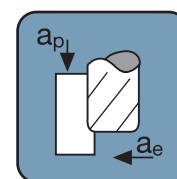

**HSM-Schnittwertempfehlung · HSM-Recommended cutting data ·  
Paramètres de coupe UGV · Parametri – Alta velocità**

MAT	1.4-1.5									
	HRC < 40		HRC 40 ~ 49		HRC 50 ~ 54		HRC 55 ~ 59		HRC 60 ~ 65	
d <sub>1</sub> [mm]	n [min <sup>-1</sup> ]	v <sub>f</sub> [mm/min]	n [min <sup>-1</sup> ]	v <sub>f</sub> [mm/min]	n [min <sup>-1</sup> ]	v <sub>f</sub> [mm/min]	n [min <sup>-1</sup> ]	v <sub>f</sub> [mm/min]	n [min <sup>-1</sup> ]	v <sub>f</sub> [mm/min]
2	29.000	15.000	22.000	9.800	15.000	7.850	11.000	4.450	8.700	2.450
3	22.000	16.000	17.000	10.000	12.500	8.000	9.500	4.600	6.900	2.500
4	17.000	17.500	13.000	12.000	11.000	9.200	8.000	5.500	5.600	2.900
5	15.000	18.000	11.000	12.500	10.000	10.000	7.000	6.000	4.900	3.100
6	13.500	18.500	10.500	13.800	9.000	11.000	6.400	6.400	4.500	3.600
8	10.000	18.500	8.000	14.000	6.800	11.000	4.800	6.700	3.400	4.100
10	8.000	18.500	6.400	14.000	5.400	11.000	3.800	6.800	2.700	3.800
12	6.600	18.500	5.300	14.000	4.500	11.000	3.200	7.000	2.250	3.600
a <sub>p</sub>	0,1 x R					0,05 x R				
a <sub>e</sub>	0,3 x d <sub>1</sub>					0,3 x d <sub>1</sub>				

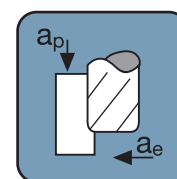

R = Eckenradius · Corner radius · Fraise rayonnée · Raggio sugli spigoli

**TN4TA-HM**

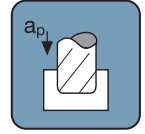
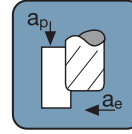

MAT	1.1-1.4; 2.1-2.4 HRC 20-30	1.3-1.5; 2.1-2.4 HRC 30-45	1.3-1.5 HRC 45-55	1.3-1.5 HRC 55-60	5 HRC <45	1.6 HRC <25
<b>Seitenfräsen · Side milling · Contournage · Contornatura</b>						
d <sub>1</sub> [mm]	n [min <sup>-1</sup> ]	v <sub>f</sub> [mm/min]	n [min <sup>-1</sup> ]	v <sub>f</sub> [mm/min]	n [min <sup>-1</sup> ]	v <sub>f</sub> [mm/min]
4,0	8760	525	7170	430	5970	360
6,0	5840	585	4780	480	3980	400
8,0	4380	615	3580	500	2990	420
10,0	3500	560	2870	460	2390	380
12,0	2920	585	2390	480	1990	400
16,0	2190	570	1790	465	1490	390
Ø d <sub>1</sub>	4,0 ~ 16,0		4,0 ~ 16,0		4,0 ~ 16,0	
a <sub>p</sub>	1,5 x d <sub>1</sub>		1,0 x d <sub>1</sub>		1,5 x d <sub>1</sub>	
a <sub>e</sub>	0,2 x d <sub>1</sub>		0,05 x d <sub>1</sub>		0,1 x d <sub>1</sub>	
MAT	1.1-1.4; 2.1-2.4 HRC 20-30	1.3-1.5; 2.1-2.4 HRC 30-45	1.3-1.5 HRC 45-55	1.3-1.5 HRC 55-60	5 HRC <45	1.6 HRC <25
<b>Nutenfräsen · Slotting · Rainurage · Cave</b>						
d <sub>1</sub> [mm]	n [min <sup>-1</sup> ]	v <sub>f</sub> [mm/min]	n [min <sup>-1</sup> ]	v <sub>f</sub> [mm/min]	n [min <sup>-1</sup> ]	v <sub>f</sub> [mm/min]
4,0	7170	430	5970	360	4780	285
6,0	4780	380	3980	320	3180	255
8,0	3590	360	2990	300	2390	240
10,0	2870	400	2390	335	1910	270
12,0	2390	380	1990	320	1590	255
16,0	1800	400	1490	330	1190	260
Ø d <sub>1</sub>	4,0 ~ 16,0		4,0 ~ 16,0		4,0 ~ 16,0	
a <sub>p</sub>	0,5 x d <sub>1</sub>		0,1 x d <sub>1</sub>		0,5 x d <sub>1</sub>	
a <sub>e</sub>	1,0 x d <sub>1</sub>		1,0 x d <sub>1</sub>		1,0 x d <sub>1</sub>	

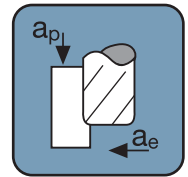

Korrekturfaktoren ·  
Correction factors ·  
Facteurs de correction ·  
Fattori di correzione:

$a_e \times 1,5 \rightarrow v_f \times 0,8$

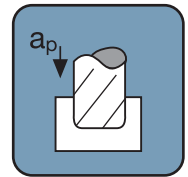

Korrekturfaktoren ·  
Correction factors ·  
Facteurs de correction ·  
Fattori di correzione:

$a_p \times 0,5 \rightarrow v_f \times 1,25$

**SK4UGTA-HM / SL4UGTA-HM**

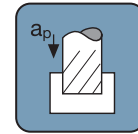
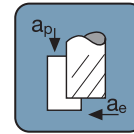

MAT	1.1-1.4; 2.1-2.4 HRC <20	1.3-1.5; 2.1-2.4 HRC 20-30	1.3-1.5 HRC 30-38	1.3-1.5 HRC 38-45	1.6 HRC 25	5 HRC <45
<b>Seitenfräsen · Side milling · Contournage · Contornatura</b>						
d <sub>1</sub> [mm]	n [min <sup>-1</sup> ]	v <sub>f</sub> [mm/min]	n [min <sup>-1</sup> ]	v <sub>f</sub> [mm/min]	n [min <sup>-1</sup> ]	v <sub>f</sub> [mm/min]
4	15.920	1.710	14.330	1.540	13.530	1.455
5	12.740	1.710	11.460	1.540	10.830	1.455
6	10.620	1.710	9.550	1.540	9.020	1.455
8	7.960	1.710	7.170	1.540	6.770	1.455
10	6.370	1.710	5.730	1.540	5.420	1.455
12	5.310	1.710	4.780	1.540	4.510	1.455
14	4.550	1.710	4.100	1.540	3.870	1.455
16	3.980	1.710	3.590	1.540	3.390	1.455
18	3.540	1.710	3.190	1.540	3.010	1.455
20	3.190	1.710	2.870	1.540	2.710	1.455
25	2.550	1.710	2.300	1.545	2.170	1.455
a <sub>p</sub>	1,0 x d <sub>1</sub>					
a <sub>e</sub>	0,5 x d <sub>1</sub>					

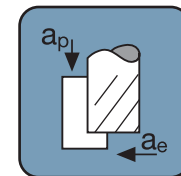

Korrekturfaktoren ·  
Correction factors ·  
Facteurs de correction ·  
Fattori di correzione:

$a_p \times 1,5 \rightarrow v_f \times 0,8$   
 $a_e \times 0,5 \rightarrow v_f \times 1,5$   
 $a_e = 0,1 \times d_1 \rightarrow n \times 1,25$

MAT	1.1-1.4; 2.1-2.4 HRC <20	1.3-1.5; 2.1-2.4 HRC 20-30	1.3-1.5 HRC 30-38	1.3-1.5 HRC 38-45	1.6 HRC 25	5 HRC <45
<b>Nutenfräsen · Slotting · Rainurage · Cave</b>						
d <sub>1</sub> [mm]	n [min <sup>-1</sup> ]	v <sub>f</sub> [mm/min]	n [min <sup>-1</sup> ]	v <sub>f</sub> [mm/min]	n [min <sup>-1</sup> ]	v <sub>f</sub> [mm/min]
4	14.330	1.380	12.740	1.225	11.940	1.150
5	11.460	1.380	10.190	1.225	9.550	1.150
6	9.550	1.380	8.490	1.225	7.960	1.150
8	7.170	1.380	6.370	1.225	5.970	1.150
10	5.730	1.380	5.100	1.225	4.780	1.150
12	4.780	1.380	4.250	1.225	3.980	1.150
14	4.100	1.380	3.640	1.225	3.420	1.150
16	3.590	1.380	3.190	1.225	2.990	1.150
18	3.190	1.380	2.830	1.225	2.660	1.150
20	2.870	1.380	2.550	1.225	2.390	1.150
25	2.300	1.380	2.040	1.225	1.910	1.150
a <sub>p</sub>	1,0 x d <sub>1</sub>		0,75 x d <sub>1</sub>		0,5 x d <sub>1</sub>	
a <sub>e</sub>	d <sub>1</sub>		d <sub>1</sub>		d <sub>1</sub>	

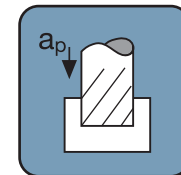

Korrekturfaktoren ·  
Correction factors ·  
Facteurs de correction ·  
Fattori di correzione:

$a_p \times 0,5 \rightarrow v_f \times 1,25$

**Korrekturfaktoren · Correction factors · Facteurs de correction · Fattori di correzione**

Typ · Type · Type · Tipo	SK4UGTA-HM	SL4UGTA-HM
Faktor · Factor · Facteur · Fattore n & v <sub>f</sub>	x 1,00	x 0,90

**SL4HRTA-HM**

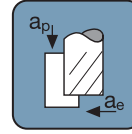

MAT	1.1-1.4; 2.1-2.4 HRC <20		1.3-1.5; 2.1-2.4 HRC 20-30		1.3-1.5 HRC 30-38		1.3-1.5 HRC 38-45		1.6 HRC 25		5 HRC <45	
<b>Seitenfräsen · Side milling · Contournage · Contornatura</b>												
d <sub>1</sub> [mm]	n [min <sup>-1</sup> ]	v <sub>f</sub> [mm/min]	n [min <sup>-1</sup> ]	v <sub>f</sub> [mm/min]	n [min <sup>-1</sup> ]	v <sub>f</sub> [mm/min]	n [min <sup>-1</sup> ]	v <sub>f</sub> [mm/min]	n [min <sup>-1</sup> ]	v <sub>f</sub> [mm/min]	n [min <sup>-1</sup> ]	v <sub>f</sub> [mm/min]
4	19.100	2.050	15.520	1.665	13.530	1.455	12.740	1.105	7.960	535	7.170	465
5	15.280	2.050	12.420	1.665	10.830	1.455	10.190	1.105	6.370	540	5.730	465
6	12.740	2.050	10.350	1.665	9.020	1.455	8.490	1.105	5.310	540	4.780	465
8	9.550	2.050	7.760	1.665	6.770	1.455	6.370	1.105	3.980	535	3.590	465
10	7.640	2.050	6.210	1.665	5.420	1.455	5.100	1.105	3.190	540	2.870	465
12	6.370	2.050	5.180	1.670	4.510	1.455	4.250	1.105	2.660	540	2.390	465
14	5.460	2.050	4.440	1.670	3.870	1.455	3.640	1.105	2.280	540	2.050	465
16	4.780	2.050	3.880	1.665	3.390	1.455	3.190	1.105	1.990	535	1.800	465
18	4.250	2.055	3.450	1.665	3.010	1.455	2.830	1.105	1.770	540	1.600	465
20	3.820	2.050	3.110	1.670	2.710	1.455	2.550	1.105	1.600	540	1.440	465
a <sub>p</sub>	1,0 x d <sub>1</sub>											
a <sub>e</sub>	0,5 x d <sub>1</sub>											
MAT	1.1-1.4; 2.1-2.4 HRC <20		1.3-1.5; 2.1-2.4 HRC 20-30		1.3-1.5 HRC 30-38		1.3-1.5 HRC 38-45		1.6 HRC 25		5 HRC <45	
<b>Nutenfräsen · Slotting · Rainurage · Cave</b>												
d <sub>1</sub> [mm]	n [min <sup>-1</sup> ]	v <sub>f</sub> [mm/min]	n [min <sup>-1</sup> ]	v <sub>f</sub> [mm/min]	n [min <sup>-1</sup> ]	v <sub>f</sub> [mm/min]	n [min <sup>-1</sup> ]	v <sub>f</sub> [mm/min]	n [min <sup>-1</sup> ]	v <sub>f</sub> [mm/min]	n [min <sup>-1</sup> ]	v <sub>f</sub> [mm/min]
4	16.720	1.610	13.530	1.300	11.150	1.075	9.950	860	6.370	430	4.780	280
5	13.370	1.605	10.830	1.300	8.920	1.075	7.960	860	5.100	430	3.820	280
6	11.150	1.610	9.020	1.300	7.430	1.070	6.640	865	4.250	430	3.190	280
8	8.360	1.610	6.770	1.300	5.580	1.075	4.980	865	3.190	430	2.390	280
10	6.690	1.610	5.420	1.305	4.460	1.075	3.980	860	2.550	430	1.910	280
12	5.580	1.610	4.510	1.300	3.720	1.075	3.320	865	2.130	430	1.600	280
14	4.780	1.610	3.870	1.305	3.190	1.075	2.850	865	1.820	430	1.370	280
16	4.180	1.610	3.390	1.305	2.790	1.075	2.490	865	1.600	435	1.200	280
18	3.720	1.610	3.010	1.305	2.480	1.075	2.220	865	1.420	430	1.070	280
20	3.350	1.610	2.710	1.305	2.230	1.075	1.990	860	1.280	435	960	280
a <sub>p</sub>	1,0 x d <sub>1</sub>				0,75 x d <sub>1</sub>				0,5 x d <sub>1</sub>			
a <sub>e</sub>	d <sub>1</sub>				d <sub>1</sub>				d <sub>1</sub>			

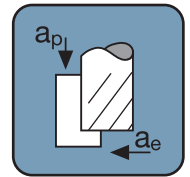

Korrekturfaktoren ·  
Correction factors ·  
Facteurs de correction ·  
Fattori di correzione:

$a_p \times 1,5 \rightarrow v_f \times 0,8$   
 $a_e \times 0,5 \rightarrow v_f \times 1,5$   
 $a_e = 0,1 \times d_1 \rightarrow n \times 1,25$

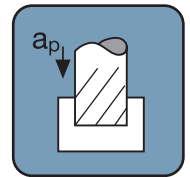

Korrekturfaktoren ·  
Correction factors ·  
Facteurs de correction ·  
Fattori di correzione:

$a_p \times 0,5 \rightarrow v_f \times 1,25$



**SLHRTA-HM**

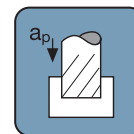
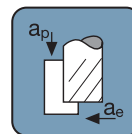

MAT	1.1-1.4; 2.1-2.4 HRC <20	1.3-1.5; 2.1-2.4 HRC 20-30	1.3-1.5 HRC 30-38	1.3-1.5 HRC 38-45	1.6 HRC 25	5 HRC <45
<b>Seitenfräsen · Side milling · Contournage · Contornatura</b>						
d <sub>1</sub> [mm]	n [min <sup>-1</sup> ]	v <sub>f</sub> [mm/min]	n [min <sup>-1</sup> ]	v <sub>f</sub> [mm/min]	n [min <sup>-1</sup> ]	v <sub>f</sub> [mm/min]
4	14.330	775	12.400	670	11.150	600
5	11.460	1.000	9.930	870	8.920	780
6	9.550	955	8.280	830	7.430	740
8	7.170	860	6.210	745	5.580	670
10	5.730	1.145	4.960	990	4.460	890
12	4.780	1.050	4.140	910	3.720	820
16	3.590	990	3.110	855	2.790	765
20	2.870	1.030	2.480	890	2.230	800
Ø d <sub>1</sub>	4,0 ~ 20,0					
a <sub>p</sub>	1,5 x d <sub>1</sub>					
a <sub>e</sub>	0,3 x d <sub>1</sub>					

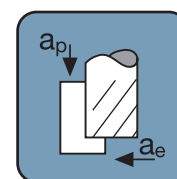

Korrekturfaktoren ·  
Correction factors ·  
Facteurs de correction ·  
Fattori di correzione:

$a_p \times 1,5 \rightarrow v_f \times 0,8$

MAT	1.1-1.4; 2.1-2.4 HRC <20	1.3-1.5; 2.1-2.4 HRC 20-30	1.3-1.5 HRC 30-38	1.3-1.5 HRC 38-45	1.6 HRC 25	5 HRC <45
<b>Nutenfräsen · Slotting · Rainurage · Cave</b>						
d <sub>1</sub> [mm]	n [min <sup>-1</sup> ]	v <sub>f</sub> [mm/min]	n [min <sup>-1</sup> ]	v <sub>f</sub> [mm/min]	n [min <sup>-1</sup> ]	v <sub>f</sub> [mm/min]
4	7.170	390	6.200	335	5.580	300
5	5.730	500	4.970	435	4.460	390
6	4.780	480	4.140	415	3.720	370
8	3.590	430	3.110	370	2.790	335
10	2.870	570	2.480	495	2.230	445
12	2.390	525	2.070	455	1.860	410
16	1.800	495	1.560	430	1.400	385
20	1.440	520	1.240	445	1.120	400
Ø d <sub>1</sub>	4,0 ~ 20,0					
a <sub>p</sub>	0,5 x d <sub>1</sub>					
a <sub>e</sub>	1,0 x d <sub>1</sub>					

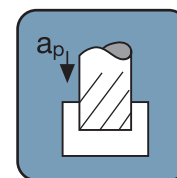

Korrekturfaktoren ·  
Correction factors ·  
Facteurs de correction ·  
Fattori di correzione:

$a_p \times 0,5 \rightarrow v_f \times 1,25$

**SKMZTA-HM**

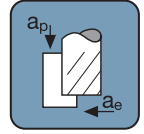

MAT	1.3-1.5; 2.1-2.4 HRC 20-30	1.3-1.5 HRC 30-44	1.3-1.5 HRC 44-55	1.3-1.5 HRC 55-60				
<b>Seitenfräsen · Sidemilling · Contournage · Contornatura</b>								
d <sub>1</sub> [mm]	n [min <sup>-1</sup> ]	v <sub>f</sub> [mm/min]	n [min <sup>-1</sup> ]	v <sub>f</sub> [mm/min]	n [min <sup>-1</sup> ]	v <sub>f</sub> [mm/min]	n [min <sup>-1</sup> ]	v <sub>f</sub> [mm/min]
3	18.580	2.120	17.520	2.000	14.860	1.340	12.740	765
4	13.930	2.090	13.140	1.970	11.150	1.340	9.550	860
6	9.290	2.170	8.760	2.050	7.430	1.385	6.370	960
8	6.970	2.220	6.570	2.090	5.570	1.405	4.780	920
10	5.570	2.140	5.250	2.020	4.460	1.340	3.820	895
12	4.640	2.200	4.380	2.080	3.720	1.320	3.180	920
14	3.980	2.080	3.750	1.960	3.180	1.245	2.730	870
16	3.480	1.980	3.280	1.870	2.790	1.190	2.390	835
18	3.100	2.530	2.920	2.380	2.480	1.590	2.120	1.105
20	2.790	2.460	2.630	2.310	2.230	1.610	1.910	1.120
a <sub>p</sub>	2,0 x d <sub>1</sub>							
a <sub>e</sub>	0,05 x d <sub>1</sub>				0,03 x d <sub>1</sub>			

M	P	∅
M 1	0,25	0,75
M 1,1	0,25	0,85
M 1,2	0,25	0,95
M 1,4	0,3	1,10
M 1,6	0,35	1,25
M 1,7	0,35	1,30
M 1,8	0,35	1,45
M 2	0,4	1,60
M 2,2	0,45	1,75
M 2,3	0,4	1,90
M 2,5	0,45	2,05
M 2,6	0,45	2,10
M 3	0,5	2,50
M 3,5	0,6	2,90
M 4	0,7	3,30
M 4,5	0,75	3,70
M 5	0,8	4,20
M 6	1	5,00
M 7	1	6,00
M 8	1,25	6,80
M 9	1,25	7,80
M10	1,5	8,50
M11	1,5	9,50
M12	1,75	10,20
M14	2	12,00
M16	2	14,00
M18	2,5	15,50
M20	2,5	17,50
M22	2,5	19,50
M24	3	21,00
M27	3	24,00
M30	3,5	26,50
M33	3,5	29,50
M36	4	32,00
M39	4	35,00
M42	4,5	37,50
M45	4,5	40,50
M48	5	43,00
M52	5	47,00

MF	P	∅
M 2 x	0,25	1,75
M 2,5 x	0,35	2,15
M 3 x	0,35	2,65
M 3,5 x	0,35	3,15
M 4 x	0,35	3,65
M 4 x	0,5	3,50
M 5 x	0,5	4,50
M 6 x	0,5	5,50
M 6 x	0,75	5,20
M 7 x	0,75	6,20
M 8 x	0,5	7,50
M 8 x	0,75	7,20
M 8 x	1	7,00
M 9 x	1	8,00
M10 x	0,75	9,20
M10 x	1	9,00
M10 x	1,25	8,80
M11 x	1	10,00
M12 x	1	11,00
M12 x	1,25	10,75
M12 x	1,5	10,50
M14 x	1	13,00
M14 x	1,25	12,80
M14 x	1,5	12,50
M15 x	1	14,00
M15 x	1,5	13,50
M16 x	1	15,00
M16 x	1,5	14,50
M18 x	1	17,00
M18 x	1,5	16,50
M18 x	2	16,00
M20 x	1	19,00
M20 x	1,5	18,50
M20 x	2	18,00
M22 x	1	21,00
M22 x	1,5	20,50
M22 x	2	20,00
M24 x	1	23,00
M24 x	1,5	22,50
M24 x	2	22,00
M25 x	1,5	23,50
M26 x	1,5	24,50
M27 x	1,5	25,50
M27 x	2	25,00
M28 x	1,5	26,50
M30 x	1	29,00
M30 x	1,5	28,50
M30 x	2	28,00

EG-M	P	∅
EG M 2,5	0,45	2,65
EG M 3	0,5	3,15
EG M 3,5	0,6	3,70
EG M 4	0,7	4,20
EG M 5	0,8	5,25
EG M 6	1	6,30
EG M 8	1,25	8,40
EG M 10	1,5	10,50
EG M 12	1,75	12,50
EG M 14	2	14,50
EG M 16	2	16,50

MJ	P	∅
MJ 3 x	0,5	2,60
MJ 4 x	0,7	3,40
MJ 5 x	0,8	4,30
MJ 6 x	1	5,10
MJ 8 x	1,25	6,90
MJ 10 x	1,5	8,70
MJ 12 x	1,75	10,50
MJ 16 x	2	14,30

G	P/1"	∅
G 1/8 - 28		8,80
G 1/4 - 19		11,80
G 3/8 - 19		15,25
G 1/2 - 14		19,00
G 5/8 - 14		21,00
G 3/4 - 14		24,50
G 7/8 - 11		28,25
G 1 - 11		30,75
G 1 1/8 - 11		35,50
G 1 1/4 - 11		39,50
G 1 3/8 - 11		41,90
G 1 1/2 - 11		45,25
G 1 3/4 - 11		51,00
G 2 - 11		57,00

UN-8	P/1"	∅
UN-8 1 1/8 - 8		25,40
UN-8 1 1/4 - 8		28,50
UN-8 1 1/2 - 8		35,00
UN-8 1 3/4 - 8		41,50
UN-8 2 - 8		48,00

Pg	P/1"	∅
Pg 7 - 20		11,40
Pg 9 - 18		14,00
Pg 11 - 18		17,25
Pg 13,5 - 18		19,00
Pg 16 - 18		21,25
Pg 21 - 16		27,00
Pg 29 - 16		35,50

NPT	P/1"	∅
NPT 1/16 - 27		6,30
NPT 1/8 - 27		8,50
NPT 1/4 - 18		11,10
NPT 3/8 - 18		14,50
NPT 1/2 - 14		17,75
NPT 3/4 - 14		23,20
NPT 1 - 11,5		29,00

UNC	P/1"	∅
UNC # 1 - 64		1,55
UNC # 2 - 56		1,85
UNC # 3 - 48		2,10
UNC # 4 - 40		2,35
UNC # 5 - 40		2,65
UNC # 6 - 32		2,85
UNC # 8 - 32		3,50
UNC # 10 - 24		3,90
UNC # 12 - 24		4,50
UNC 1/4 - 20		5,10
UNC 5/16 - 18		6,60
UNC 3/8 - 16		8,00
UNC 7/16 - 14		9,40
UNC 1/2 - 13		10,80
UNC 9/16 - 12		12,20
UNC 5/8 - 11		13,50
UNC 3/4 - 10		16,50
UNC 7/8 - 9		19,50
UNC 1 - 8		22,25
UNC 1 1/8 - 7		25,00

UNJC	P/1"	∅
UNJC # 4 - 40		2,30
UNJC # 6 - 32		2,85
UNJC # 8 - 32		3,50
UNJC # 10 - 24		3,90
UNJC 1/4 - 20		5,25
UNJC 5/16 - 18		6,70
UNJC 3/8 - 16		8,10

UNF	P/1"	∅
UNF # 0 - 80		1,25
UNF # 1 - 72		1,55
UNF # 2 - 64		1,85
UNF # 3 - 56		2,10
UNF # 4 - 48		2,40
UNF # 5 - 44		2,70
UNF # 6 - 40		3,00
UNF # 8 - 36		3,50
UNF # 10 - 32		4,10
UNF # 12 - 28		4,65
UNF 1/4 - 28		5,50
UNF 5/16 - 24		6,90
UNF 3/8 - 24		8,50
UNF 7/16 - 20		9,90
UNF 1/2 - 20		11,50
UNF 9/16 - 18		12,90
UNF 5/8 - 18		14,50
UNF 3/4 - 16		17,50
UNF 7/8 - 14		20,40
UNF 1 - 12		23,25
UNF 1 1/8 - 12		26,50
UNF 1 1/4 - 12		29,50
UNF 1 3/8 - 12		32,75
UNF 1 1/2 - 12		36,00

UNJF	P/1"	∅
UNJF # 6 - 40		3,00
UNJF # 8 - 36		3,55
UNJF # 10 - 32		4,15
UNJF 1/4 - 28		5,55
UNJF 5/16 - 24		7,00
UNJF 3/8 - 24		8,60

M	P	∅					
		6HX		6GX		7GX	
		min.	max.	min.	max.	min.	max.
M 1	0,25	0,89	0,91				
M 1,1	0,25	0,99	1,01				
M 1,2	0,25	1,09	1,11				
M 1,4	0,3	1,27	1,29				
M 1,6	0,35	1,45	1,47				
M 1,7	0,35	1,55	1,57				
M 1,8	0,35	1,65	1,67				
M 2	0,4	1,82	1,84	1,85	1,88		
M 2,2	0,45	2,01	2,04	2,02	2,06		
M 2,3	0,4	2,12	2,14				
M 2,5	0,45	2,31	2,34	2,32	2,36		
M 2,6	0,45	2,41	2,44				
M 3	0,5	2,78	2,81	2,79	2,84	2,81	2,85
M 3,5	0,6	3,23	3,27	3,24	3,30		
M 4	0,7	3,67	3,71	3,69	3,73	3,71	3,77
M 4,5	0,75	4,15	4,21				
M 5	0,8	4,62	4,67	4,65	4,71	4,66	4,73
M 6	1	5,50	5,56	5,55	5,63	5,56	5,64
M 7	1	6,50	6,56				
M 8	1,25	7,36	7,44	7,40	7,47	7,42	7,50
M 9	1,25	8,36	8,44				
M10	1,5	9,22	9,31	9,26	9,35	9,30	9,39
M11	1,5	10,22	10,31				
M12	1,75	11,08	11,19	11,14	11,24	11,17	11,28
M14	2	12,96	13,08	13,00	13,12	13,04	13,16
M16	2	14,96	15,08	15,00	15,12	15,04	15,16
M18	2,5	16,66	16,81				
M20	2,5	18,66	18,81				
M22	2,5	20,66	20,81				
M24	3	22,39	22,56				
M27	3	25,39	25,56				
M30	3,5	28,09	28,28				
M33	3,5	31,09	31,28				
M36	4	33,80	34,01				
M39	4	36,80	37,01				
M42	4,5	39,52	39,73				
M45	4,5	42,52	42,73				

MF	P	∅	
		min.	max.
		M 2 x	0,25
M 2,5 x	0,35	2,35	2,37
M 3 x	0,35	2,85	2,87
M 3,5 x	0,35	3,35	3,37
M 4 x	0,35	3,85	3,88
M 4 x	0,5	3,77	3,80
M 5 x	0,5	4,77	4,80
M 6 x	0,5	5,78	5,83
M 6 x	0,75	5,64	5,69
M 7 x	0,75	6,64	6,69
M 8 x	0,5	7,78	7,83
M 8 x	0,75	7,64	7,69
M 8 x	1	7,50	7,56
M 9 x	1	8,50	8,56
M10 x	0,75	9,64	9,69
M10 x	1	9,50	9,56
M10 x	1,25	9,35	9,43
M11 x	1	10,50	10,56
M12 x	1	11,50	11,56
M12 x	1,25	11,35	11,43
M12 x	1,5	11,21	11,30
M14 x	1	13,52	13,58
M14 x	1,25	13,40	13,49
M14 x	1,5	13,24	13,33
M15 x	1	14,52	14,60
M15 x	1,5	14,26	14,36
M16 x	1	15,52	15,58
M16 x	1,5	15,24	15,33
M18 x	1,5	17,25	17,34
M20 x	1,5	19,25	19,34
M22 x	1,5	21,25	21,37
M24 x	1,5	23,25	23,37

UNC	P/1"	∅	
		min.	max.
		UNC # 5 - 40	
UNC # 6 - 32		3,09	3,17
UNC # 8 - 32		3,76	3,84
UNC # 10 - 24		4,26	4,35
UNC 1/4 - 20		5,66	5,76
UNC 5/16 - 18		7,18	7,29
UNC 3/8 - 16		8,66	8,78
UNC 7/16 - 14		10,12	10,27
UNC 1/2 - 13		11,62	11,78
UNC 9/16 - 12		13,14	13,28
UNC 5/8 - 11		14,61	14,76
UNC 3/4 - 10		17,65	17,80
UNC 7/8 - 9		20,66	20,84
UNC 1 - 8		23,63	23,84

UNF	P/1"	∅	
		min.	max.
		UNF # 6 - 40	
UNF # 10 - 32		4,41	4,47
UNF 1/4 - 28		5,87	5,94
UNF 5/16 - 24		7,39	7,47
UNF 3/8 - 24		8,98	9,06
UNF 7/16 - 20		10,45	10,55
UNF 1/2 - 20		12,05	12,14
UNF 9/16 - 18		13,56	13,64
UNF 5/8 - 18		15,15	15,23
UNF 3/4 - 16		18,22	18,30
UNF 7/8 - 14		21,27	21,38
UNF 1 - 12		24,26	24,37

G	P/1"	∅	
		min.	max.
		G 1/8 - 28	
G 1/4 - 19		12,43	12,53
G 3/8 - 19		15,94	16,04
G 1/2 - 14		19,93	20,15



R <sub>m</sub> [N/mm <sup>2</sup> ]	HV 10	HB	HRC
240	75	71	–
255	80	76	–
270	85	81	–
285	90	86	–
305	95	90	–
320	100	95	–
335	105	100	–
350	110	105	–
370	115	109	–
385	120	114	–
400	125	119	–
415	130	124	–
430	135	128	–
450	140	133	–
465	145	138	–
480	150	143	–
495	155	147	–
510	160	152	–
530	165	157	–
545	170	162	–
560	175	166	–
575	180	171	–
595	185	176	–
610	190	181	–
625	195	185	–
640	200	190	–
660	205	195	–
675	210	199	–
690	215	204	–
705	220	209	–
720	225	214	–
740	230	219	–
755	235	223	–
770	240	228	–
785	245	233	–
800	250	238	22
820	255	242	23
835	260	247	24
860	268	255	25
870	272	258	26
900	280	266	27

R <sub>m</sub> [N/mm <sup>2</sup> ]	HV 10	HB	HRC
920	287	273	28
940	293	278	29
970	302	287	30
995	310	295	31
1020	317	301	32
1050	327	311	33
1080	336	319	34
1110	345	328	35
1140	355	337	36
1170	364	346	37
1200	373	354	38
1230	382	363	39
1260	392	372	40
1300	403	383	41
1330	413	393	42
1360	423	402	43
1400	434	413	44
1440	446	424	45
1480	458	435	46
1530	473	449	47
1570	484	460	48
1620	497	472	49
1680	514	488	50
1730	527	501	51
1790	544	517	52
1845	560	532	53
1910	578	549	54
1980	596	567	55
2050	615	584	56
2140	639	607	57
–	655	622	58
–	675	–	59
–	698	–	60
–	720	–	61
–	745	–	62
–	773	–	63
–	800	–	64
–	829	–	65
–	864	–	66
–	900	–	67
–	940	–	68

Werkstoffübersicht nach Werkstoffnummer (W.-Nr.)  
 Work material overview according material-no. (W.-Nr.)  
 Index-Groupe de matières selon numéro (W.-Nr.)  
 Materiali da lavorare secondo nr. materiale (W.-Nr.)

W.-Nr.	DIN (DE)	Werkstoffgruppen Classification of work materials Groupes de matières Gruppo materiali	W.-Nr.	DIN (DE)	Werkstoffgruppen Classification of work materials Groupes de matières Gruppo materiali
-	AFK Armidfaserverstärkt	7.3	1.0552	GS-52	1.1.3
-	Albanit	7.2	1.0558	GS-60	1.1.3
-	AMPCO 8	3.4	1.0570	St 52-3	1.1.1
-	AMPCO 12	3.4	1.0582	StE 355	1.1.4
-	AMPCO 15	3.4	1.0710	15 S 10	1.2.3
-	AMPCO 16	3.4	1.0715	9 SMn 28	1.2.3
-	AMPCO 18	3.5	1.0718	9 SMnPb 28	1.2.3
-	AMPCO 20	3.5	1.0721	10 S 20	1.2.3
-	AMPCO 21	3.6	1.0722	10 SPb 20	1.2.3
-	AMPCO 22	3.6	1.0723	15 S 20	1.2.3
-	AMPCO 25	3.6	1.0726	35 S 20	1.2.3
-	AMPCO 26	3.6	1.0727	45 S 20	1.2.3
-	ASP 23	1.5.3/8.2	1.0736	9 SMn 36	1.2.3
-	ASP 30	1.5.3/8.2	1.0737	9 SMnPb 36	1.2.3
-	ASP 60	1.5.3/8.2	1.1121	Ck 10	1.2.1
-	Bakelit	7.2	1.1132	Cq 15	1.2.4
-	CFK Kohlefaserverstärkt	7.3	1.1133	20 Mn 5	1.3.4/1.4.1
-	CPM 10 V	1.5.2/8.2	1.1140	Cm 15 (C 15 R)	1.2.1
-	CPM REX M4	1.5.3/8.2	1.1141	Ck 15	1.2.1
-	Degolan	7.1	1.1151	Ck 22	1.2.2
-	Ferrotic	8.1	1.1152	Cq 22	1.2.4
-	Ferrotitanit	8.1	1.1157	40 Mn 4	1.3.4
-	Ferrozell	7.2	1.1157	40 Mn 4 V	1.4.1
-	G-AlSi 17 Cu 4	4.5	1.1169	20 Mn 6	1.3.1
-	G-AlSi 21 CuNiMg	4.5	1.1170	28 Mn 6	1.3.4
-	G-AlSi 25 CuNiMg	4.5	1.1170	28 Mn 6 V	1.4.1
-	GFK Glasfaserverstärkt	7.3	1.1172	Cq 35	1.2.4
-	GGV-30	2.4	1.1178	Ck 30	1.2.2
-	GGV-40	2.4	1.1180	Cm 35	1.2.2
-	HARDOX 400	1.4.4	1.1181	Ck 35	1.2.2
-	HARDOX 500	8.2.1	1.1191	Ck 45	1.2.2
-	Hostaform	7.1	1.1192	Cq 45	1.2.4
-	Hostalen	7.1	1.1520	C 70 W1	1.5.1/8.2
-	Makralon	7.1	1.1525	C 80 W1	1.5.1/8.2
-	Pertinax	7.2	1.1545	C 105 W1	1.5.1/8.2
-	Polystyrol	7.1	1.1554	C 110 W	1.5.1/8.2
-	Resopal	7.2	1.1730	C 45 W	1.5.1/8.2
-	TOOLOX 33	1.5.2/8.2	1.1740	C 60 W	1.5.1/8.2
-	TOOLOX 44	8.2.1	1.1744	C 67 W	1.5.1/8.2
-	Ultramit	7.1	1.1820	C 55 W	1.5.1/8.2
-	VANADIS 4	1.5.2/8.2	1.2080	X 210 Cr 12	1.5.2/8.2
-	VANADIS 10	1.5.2/8.2	1.2083	X 42Cr 13	1.5.4/8.2
0.6010	GG-10	2.1	1.2127	105 MnCr 4	1.5.2/8.2
0.6015	GG-15	2.1	1.2201	X 165 CrV 12	1.5.2/8.2
0.6020	GG-20	2.1	1.2303	100 CrMo 5	1.5.2/8.2
0.6025	GG-25	2.1	1.2309	65 MnCrMo 4	1.5.5/8.2
0.6030	GG-30	2.2	1.2311	40 CrMnMo 7	1.5.5/8.2
0.6035	GG-35	2.2	1.2312	40 CrMnMoS 8 6	1.5.4/8.2
0.6040	GG-40	2.2	1.2316	X 36CrMo 17	1.5.4/8.2
0.7033	GGG-35.3	2.3	1.2343	X 38CrMoV 5 1	1.5.5/8.2
0.7040	GGG-40	2.3	1.2344	X 40 CrMoV 5 1	1.5.5/8.2
0.7043	GGG-40.3	2.3	1.2363	X 100 CrMoV 5 1	1.5.2/8.2
0.7050	GGG-50	2.3	1.2367	X 38 CrMoV 5 3	1.5.5/8.2
0.7060	GGG-60	2.3	1.2379	X155 CrMoV 12 1	1.5.2/8.2
0.8035	GTW-35-04	2.3	1.2436	X 210 CrW 12	1.5.2/8.2
0.8040	GTW-40-05	2.3	1.2601	X 165 CrMoV 12	1.5.2/8.2
0.8045	GTW-45-07	2.3	1.2622	X 60 WCrMoV 9 4	1.5.5/8.2
0.8055	GTW-55	2.3	1.2678	X 45 CrCoWV 5 5 5	1.5.5/8.2
0.8065	GTW-65	2.3	1.2731	X 50 NiCrWV 13 13	1.5.5/8.2
0.8135	GTS-35-10	2.3	1.2767	X 45 NiCrMo 4	1.5.5/8.2
0.8145	GTS-45-06	2.3	1.2842	90 MnCrV 8	1.5.2/8.2
0.8155	GTS-55-04	2.3	1.2880	X 165 CrCoMo 12	1.5.2/8.2
0.8165	GTS-65-02	2.3	1.2884	X 210 CrCoW 12	1.5.2/8.2
1.0035	St 33	1.1.1	1.2889	X 45 CoCrMoV 5 5 3	1.5.5/8.2
1.0037	St 37-2	1.1.1	1.2889	X 45 CoCrMoV 5 5 3	1.5.5/8.2
1.0044	St 44-2	1.1.1	1.3243	S 6-5-2-5	1.5.3/8.2
1.0050	St 50-2	1.1.1	1.3343	S 6-5-2	1.5.3/8.2
1.0060	St 60-2	1.1.1	1.3344	S 6-5-3	1.5.3/8.2
1.0070	St 70-2	1.1.1	1.3346	S 2-9-1	1.5.3/8.2
1.0116	St 37-3	1.1.1	1.3348	S 2-9-2	1.5.3/8.2
1.0120	St 37	1.1.1	1.3401	X 120 Mn 12	1.4.4
1.0140	St 42	1.1.1	1.3501	100 Cr 2 (W1)	1.4.2
1.0144	St 44-3	1.1.1	1.3503	105 Cr 4 (W2)	1.4.2
1.0181	St 42-2	1.1.1	1.3505	100 Cr 6 (W3)	1.4.2
1.0301	C 10	1.2.1	1.3520	100 CrMn 6 (W4)	1.4.2
1.0345	H I	1.1.2	1.3543	X 102 CrMo 17	1.4.2
1.0401	C 15	1.2.1	1.3956	X 8 CrNi 18 12	1.6.2
1.0402	C 22	1.2.2	1.4000	X 6 Cr 13	1.6.3
1.0420	GS-38	1.1.3	1.4002	X 6 CrAl 13	1.6.3
1.0425	H II	1.1.2	1.4005	X 12 CrS 13	1.6.5/8.2
1.0435	H III	1.1.2	1.4006	X 10 Cr 13	1.6.5/8.2
1.0443	GS-45	1.1.3	1.4008	G-X 8 CrNi 13	1.6.3
1.0445	H IV	1.1.2	1.4016	X 6 Cr 17	1.6.3
1.0461	StE 255	1.1.4	1.4021	X 20 Cr 13	1.6.5/8.2
1.0482	19 Mn 5	1.3.2	1.4024	X 15 Cr 13	1.6.5/8.2
1.0501	C 35	1.2.2	1.4027	G-X 20 Cr 14	1.6.3
1.0503	C 45	1.2.2	1.4028	X 30 Cr 13	1.6.5/8.2
1.0528	C 30	1.2.2	1.4034	X 46 Cr 13	1.6.5/8.2
1.0531	St 50	1.1.1	1.4057	X 20 CrNi 17 2	1.6.5/8.2

Werkstoffübersicht nach Werkstoffnummer (W.-Nr.)  
 Work material overview according material-no. (W.-Nr.)  
 Index-Groupe de matières selon numéro (W.-Nr.)  
 Materiali da lavorare secondo nr. materiale (W.-Nr.)

W.-Nr.	DIN (DE)	Werkstoffgruppen Classification of work materials Groupes de matières Gruppo materiali	W.-Nr.	DIN (DE)	Werkstoffgruppen Classification of work materials Groupes de matières Gruppo materiali
1.4059	G-X 22 CrNi 17	1.6.3	2.0360	CuZn 40 (Ms60)	3.2
1.4104	X 12 CrMoS 17	1.6.1	2.0380	CuZn 39 Pb 2 (Ms58)	3.2
1.4105	X 4 CrMoS 18	1.6.1	2.0410	CuZn 44 Pb 2 (Ms 56)	3.2
1.4106	X 10 CrMo 13	1.6.5/8.2	2.0561	CuZn 40 Al 1	3.2
1.4112	X 90 CrMoV 18	1.6.5/8.2	2.0580	CuZn 40 Mn 1 Pb	3.2
1.4113	X 6 CrMo 17	1.6.3	2.0771	CuNi 7 Zn 39 Mn 5 Pb 3	3.2
1.4116	X 45 CrMoV 15	1.6.5/8.2	2.0916	CuAl 5 (AlBz 5)	3.4
1.4138	G-X 120 CrMo 29 2	1.6.5/8.2	2.0932	CuAl 8 Fe 3 (AlBz 8 Fe)	3.4
1.4300	X 12 CrNi 18 8	1.6.2	2.0966	CuAl 10 Ni 5 Fe 4	3.4
1.4301	X 5 CrNi 18 10	1.6.2	2.0978	CuAl 11 Ni 6 Fe 5	3.5
1.4305	X 10 CrNiS 18 9	1.6.1	2.1020	CuSn 6	3.3
1.4305	X 10 CrNiS 18 9	1.6.1	2.1030	CuSn 8	3.3
1.4308	X 6 CrNi 18 9	1.6.2	2.1050	G-CuSn 10 Zn (Rg 10)	3.2
1.4311	X 2 CrNiN 18 10	1.3.1	2.1080	CuSn 6 Zn 6	3.3
1.4312	G-X 10 CrNi 18 8	1.6.2	2.1086	G-CuSn 10	3.2
1.4406	X 2 CrNiMoN 17 12 2	1.3.1/1.6.2	2.1093	G-CuSn 6 ZnNi	3.2
1.4408	X 6 CrNiMo 18 10	1.6.2	2.1096	G-CuSn 5 ZnPb (Rg 5)	3.2
1.4410	X 3 CrNiMoN 25 7 4	1.6.2	2.1245	CuBe 1,7 F110	3.3/3.5/3.6
1.4433	X 2 CrNiMo 18 15	1.6.2	2.1247	CuBe 2	3.3/3.4/3.6
1.4435	X 2 CrNiMo 18 14 3	1.6.2	2.1293	CuCrZr	3.3
1.4460	X 8 CrNiMo 27 5	1.6.4	2.1356	CuMn 3	3.1
1.4510	X 6 CrTi 17	1.6.3	2.1504 LN	NiAlBz	6.1
1.4511	X 6 CrNb 17	1.6.3	2.1522	CuSi 2 Mn	3.1
1.4512	X 5 CrTi 12	1.6.3	2.1525	CuSi 3 Mn	3.3
1.4528	X 105 CrCoMo 18 2	1.6.3	2.4042	Ni 99 CSI	6.1
1.4536	G-X 2 NiCrMoCuN 25 20	1.6.2	2.4060	Ni 99,6	6.1
1.4541	X 6 CrNiTi 18 10	1.6.2	2.4062	Ni 99,4 Fe	6.1
1.4550	G-X 6 CrNiNb 18 10	1.6.2	2.4360	NiCu 30 Fe	6.2
1.4571	X 6 CrNiMoTi 17 12 2	1.6.2	2.4374 LN	-	6.2
1.4573	X 10 CrNiMoTi 18 12	1.6.2	2.4617	NiMo 28	6.2
1.4581	G-X 5 CrNiMoNb 18 10	1.6.2	2.4631	NiCr 20 TiAl	6.3
1.4582	X 4 CrNiMoNb 25 7	1.6.4	2.4632	NiCr 20 Co 18 Ti	6.3
1.4710	G-X 30 CrSi 6	1.6.6/8.2	2.4634	NiCo 20 Cr 15 MoAlTi	6.3
1.4712	X 10 CrSi 6	1.6.3	2.4662	-	6.3
1.4718	X 45 CrSi 9 3	1.6.6/8.2	2.4665	NiCr 22 Fe 18 Mo	6.2
1.4722	X 10 CrSi 13	1.6.3	2.4668	NiCr 19 FeNbMo	6.3
1.4729	G-X 40 CrSi 13	1.6.6/8.2	2.4670 LN	G - NiCr 13 Al 6 MoNb	6.3
1.4747	X 80 CrNiSi 20	1.6.6/8.2	2.4674 LN	NiCo 15 Cr 10 MoAlTi	6.3
1.4762	X 10 CrAl 24	1.6.3	2.4812	-	6.2
1.4821	X 20 CrNiSi 25 4	1.6.4	2.4816	NiCr 15 Fe	6.2
1.4825	G-X 25 CrNiSi 18 9	1.6.6/8.2	2.4856	NiCr 22 Mo 9 Nb	6.3
1.4848	G-X 40 CrNiSi 25 20	1.6.6/8.2	2.4876	-	6.2
1.4922	X 20 CrMoV 12 1	1.3.2	2.4983	NiCr 18 Co 18 MoTi	6.2
1.5022	38 Si 6	1.4.3	2.6554	-	6.3
1.5024	46 Si 7	1.4.3	3.0250	Al 99,5 H	4.1
1.5025	51 Si 7	1.4.3	3.0256	E-Al H	4.1
1.5142	60 SiMn 5	1.4.3	3.0280	Al 99,8 H	4.1
1.5404	21 MoV 53	1.3.2	3.0515	G-Al 99,5	4.2
1.5406	17 MoV 84	1.3.2	3.0516	S-AlMn	4.2
1.5622	14 Ni 6	1.3.1	3.0525	AlMn 1 Mg 0,5	4.2
1.5633	24 Ni 8	1.3.1	3.0615	AlMgSiPb	4.2
1.5919	GS-15 CrNi 6	1.3.5	3.1325	AlCuMg 1	4.2
1.5919	15 CrNi 6	1.4.6	3.1355	AlCuMg 2	4.2
1.7012	13 Cr 2 (EC30)	1.2.1	3.1841	G-AlCu 4 Ti	4.2
1.7015	15 Cr 3 (EC60)	1.2.1	3.2134	GD-AlSi 5 Cu 1 Mg	4.3
1.7103	67 SiCr 5	1.4.3	3.2152	GD-AlSi 6 Cu 4	4.3
1.7131	16 MnCr 5 (EC 80)	1.2.1/1.4.6	3.2162	GD-AlSi 8 Cu 3	4.3
1.7147	20 MnCr 5	1.4.6	3.2373	G-AlSi 9 Mg	4.3
1.7218	GS-25 CrMo 4	1.3.5	3.2381	G-AlSi 10 Mg	4.4
1.7218	25 CrMo 4	1.4.1	3.2383	G-AlSi 10 Mg (Cu)	4.4
1.7219	26 CrMo 4	1.3.1	3.2581	G-AlSi 12	4.4
1.7220	GS-34 CrMo 4	1.3.5	3.2583	G-AlSi 12 (Cu)	4.4
1.7220	34 CrMo 4	1.3.4/1.4.5	3.2982	GD-AlSi 12 (Cu)	4.4
1.7225	42 CrMo 4	1.3.4/1.4.5	3.3241	G-AlMg 3 Si	4.2
1.7228	50 CrMo 4	1.3.4/1.4.5	3.3292	GD-AlMg 9	4.2
1.7321	20 MoCr 4	1.4.6	3.3308	Al 99,9 Mg 0,5	4.1
1.7325	25 MoCr 4	1.4.6	3.3315	AlMg 1	4.2
1.7337	16 CrMo 4 4	1.3.2	3.3535	AlMg 3	4.2
1.7379	GS-18 CrMo 9 10	1.3.5	3.4365	AlZnMgCu 1,5	4.2
1.7701	51 CrMoV 4	1.4.3	3.5106	G-MgAg 3 SE 2 Zr 1	4.4
1.8070	21 CrMoV 5 11	1.3.2	3.5562	G-MgAl 6	4.4
1.8504	34 CrAl 6	1.3.3/1.4.7	3.5812	GD-MgAl 8 Zn 1	4.4
1.8506	34 CrAlS 5	1.3.3	3.5912	GD-MgAl 9 Zn 1	4.4
1.8507	34 CrAlMo 5	1.4.7	3.7024.1 LN	Ti 99,5	5.1
1.8509	41 CrAlMo 7	1.4.7	3.7034.1 LN	Ti 99,7	5.1
1.8515	31 CrMo 12	1.3.3/1.4.7	3.7055	Ti 99,4	5.1
1.8519	31 CrMoV 9	1.3.3	3.7064.1 LN	Ti 99,2	5.1
1.8550	34 CrAlNi 7	1.3.3/1.4.7	3.7114 LN	TiAl 5 Sn 2	5.2
1.8905	StE 460	1.1.4	3.7124 LN	TiCu 2	5.2/5.3
1.8907	StE 500	1.1.4	3.7144 LN	TiAl 6 Sn 2 Zr 4 Mo 2	5.3
1.8931	StE 690 V	1.4.8	3.7154 LN	TiAl 6 Zr 5	5.3
1.8941	StE 960 V	1.4.8	3.7163 LN	TiAl 6 V 4	5.2
2.0060	E-Cu 57	3.1	3.7164 LN	TiAl 5 V 4	5.3
2.0070	SE-Cu	3.1	3.7164 LN	TiAl 6 V 4	5.3
2.0090	SF-Cu	3.1	3.7174 LN	TiAl 6 V 6 Sn 2	5.2/5.3
2.0250	CuZn 20 (Ms80)	3.3	3.7184 LN	TiAl 4 Mo 4 Sn 2	5.3
2.0265	CuZn 30 (Ms70)	3.3			
2.0321	CuZn 37	3.3			
2.0335	CuZn 36 (Ms63)	3.3			

W-Nr.	DIN (DE)	EN (EU)	NF A (FR)	BS (GB)	UNI (IT)	SS (SE)	UNE (ES)	SAE/ASTM (US)	JIS (JP)
<b>1 Stähle – Steels – Aciers – Acciai</b>									
<b>1.1 Baustähle (Rm &lt; 800 N/mm²) – Structural steels (tensile strength &lt; 800 N/mm²) – Aciers de construction (résistance &lt; 800 N/mm²) – Acciai da costruzione (resistenza &lt; 800 N/mm²)</b>									
<b>1.1.1 Allgemeine Baustähle – General structural steels – Aciers mi-dur – Acciai per applicazioni generali</b>									
1.0035	St 33	–	A 33	–	Fe 320	–	AE 235-B	–	–
1.0037	St 37-2	S 235 JRG 2	E 24-2NE	4360-40 C	Fe 360 B	1312	–	A 570 Grade 36	STKM 12 C
1.0044	St 44-2	S 275 JR	E 28-2	4360-43 B	Fe 430 BFN	1412	AE 275-B	A 570 Grade 40	–
1.0050	St 50-2	E 295	A 50-2	4360-50 B	Fe 490	2172	–	A 570 Grade 50	SS 50
1.0060	St 60-2	–	A 60-2	4360-55 E	Fe 590	–	–	–	SM 58
1.0070	St 70-2	–	A 70-2	–	Fe 70-2	–	A 690-2	–	–
1.0116	St 37-3	Fe 360 D1(2); S 235 J2G3(4)	Fe 360 D1(2); E 24-4	Fe 360 D1(2); 4360-40 D	Fe 360 D 1(2); Fe37-3	1313	Fe 360 D 1(2); A 360 C	A 573-81 65; Grade 58	–
1.0120	St 37	–	–	–	–	–	–	–	–
1.0140	St 42	–	–	–	–	–	–	–	–
1.0144	St 44-3	Fe 430 D1(2); S 275 J2 G3 (4)	Fe 430 D1(2); E 28-4	Fe 430 D1(2); 4360 43 D	Fe 430 D1(2)	1414	Fe 430 D 1(2)	A 573-81; Grade 70	SM 41 C
1.0181	St 42-2	–	–	–	–	–	–	–	–
1.0531	St 50	–	–	–	–	–	–	–	–
1.0570	St 52-3	Fe 510 D1; S 355 J 2 G 3	Fe 510 D1; E 36-4	Fe 510 D1; 4360-50 D	Fe 510 D1	2134-01	Fe 510 D 1	Grade 50	SM 520 C
<b>1.1.2 Kesselbleche – Boiler plate – Tôles – Piastre per boiler</b>									
1.0345	H I	P 235 GH	A 37 CP; CC 12	1501 161	–	1330	F.1110; A 37 RC 1	A 515 65	SGV 410, 450, 480, 490
1.0425	H II	P 265 GH	A 42 CP; XC 25	161-400	Fe 410 1 KW	1432	A 42 RC 1	–	SGV 410, 450, 480
1.0435	H III	P 285 NH	–	–	–	–	–	–	–
1.0445	H IV	P 295 NH	–	–	–	–	–	–	–
<b>1.1.3 Stahlguss – Cast steel – Fonte d'acier -Acciai fusi</b>									
1.0420	GS-38	GE 200	E 24-2 Ne	–	–	1306	–	–	–
1.0443	GS-45	–	230-400 M	A 1	–	1305	F.221	A 27 65-35	–
1.0552	GS-52	GE 260	AF 55 C 35	A 2	–	1505	–	A 27 70-36	–
1.0558	GS-60	GE 360; S 355J 0	AF 65 C 45; E 36-3	A 3; En 50 C	Fe 510	1606	–	A 148 80-40	–
<b>1.1.4 Feinkornbaustähle – Fine-grain structural steel – Aciers frittés – Acciai a grana fina</b>									
1.0461	StE 255	S 255 N	–	–	–	–	–	–	–
1.0582	StE 355	P 355 N	–	–	–	–	–	–	–
1.8905	StE 460	P 460 N	E 460 RIFP; S 460 N	–	–	–	AE 460 KG	A 633 Grade E	–
1.8907	StE 500	S 500 N	–	–	–	–	–	–	–
<b>1.2 Unlegierte und niedriglegierte Stähle (Rm &lt; 800 N/mm²) – Unalloyed and low-alloy steel (tensile strength &lt; 800 N/mm²) – Aciers non alliés et faiblement alliés (résistance &lt; 800 N/mm²) – Acciai non e debolmente legati (resistenza &lt; 800 N/mm²)</b>									
<b>1.2.1 Einsatzstähle – Cementation steels – Aciers de cémentation – Acciai da cementazione</b>									
1.0301	C 10	–	AF 34 C 10; XC 10	045 M 10	C 10	–	–	1010	S 10 C
1.0401	C 15	–	AF 37 C 12; XC 12	080 M 15	C 15; C 16	1350	F.111	1015	S 15 C
1.1121	Ck 10	2 C 10	C 10 E; XC 10	045 M 10	C 10	1265	F.1510 – C 10 k	1010	S 10 C
1.1140	Cm 15 (C 15 R)	C 15 R	C 15 R	C 15 R	C 15 R	–	–	–	–
1.1141	Ck 15	2 C 15	C 15 E; XC 12	080 M 15	C 16	1370	F.1511 – C 16 k	1015	S 15 C
1.7012	13 Cr 2 (EC30)	–	–	–	–	–	–	–	–
1.7015	15 Cr 3 (EC60)	–	12 C 3	523 M 15	–	–	–	5015	SCr 415 (H)
1.7131	16 MnCr 5 (EC 80)	16 MnCr 5	16 MC 5; 15 D 3	527 M 17	16 MnCr 5	2511	F.1515 – 16 MnCr 5	5115	SCr 415
<b>1.2.2 Vergütungsstähle – Heat-treatable steels – Aciers d'amélioration – Acciai da bonifica</b>									
1.0402	C 22	1 C 22	AF 42 C 20; XC 25	050 A 20	C 20; C 21	1450	F.112	1020	S 22 C
1.0501	C 35	1 C 35	AF 55 C 35; XC 38	060 A 35	C 35	1550	F.113	1035	S 35 C
1.0503	C 45	1 C 45	AF 65 C 45; CC 45	080 M 46	C 45	1650	F.114; F.5110	1043; 1045	S 45 C
1.0528	C 30	1 C 30	AF 50 C 30; CC 32	080 M 30	C 30	–	–	1030	S 30 C
1.1151	Ck 22	2 C 22	C 22 E; XC 25	050 A 20; 070 M 20	C 20	–	F.1120 – C 25 k	1023; 1020	S 22 C
1.1178	Ck 30	2 C 30	C 30 E; XC 32	080 M 30	C 30	–	–	1030	S 30 C
1.1180	Cm 35	3 C 35	C 35 R; XC 32	080 M 36	–	1572-03/04	F.1135 – C 35 K – 1	–	–
1.1181	Ck 35	2 C 35	C 35 E; XC 38 H 1; 320-560 M	080 A 32; 080 M 36	C 35	1572	F.1135 – C 35 k	1035	S 35 C
1.1191	Ck 45	2 C 45	C 45 E; XC 42 H 1; XC 45	080 M 46	C 45	1672	F.1140 – C 45 k	1042; 1045	S 45 C
<b>1.2.3 Automatenstähle – Free cutting steels – Aciers de décolletage – Acciai automatici</b>									
1.0710	15 S 10	–	–	–	–	–	–	–	–
1.0715	9 SMn 28	11 SMn 28	S 250	230 M 07	CF 9 SMn 28	1912	F.2111 – 11 SMn 28	1213	SUM 22
1.0718	9 SMnPb 28	11 SMnPb 28	S 250 Pb; 35 MF 4	–	CF 9 SMnPb 28	1914	F.2112 – 11 SMnPb 28	12 L13	SUM 22 L
1.0721	10 S 20	10 S 20	10 F 1	210 M 15	CF 10 S 20	–	F.2121 – 10 S 20	1108	–
1.0722	10 SPb 20	10 SPb 20	10 Pb F 2	–	CF 10 SPb 20	–	F.2122 – 10 SPb 20	11 L 08	–
1.0723	15 S 20	–	S 300	210 A 15	–	1922	F.210.F	–	SUM 32
1.0726	35 S 20	35 S 20	35 MF 4	212 M 36	–	1957	F.210 G	1140	–
1.0727	45 S 20	45 S 20	45 MF 4	212 M 44	–	1973	–	1146	–
1.0736	9 SMn 36	–	S 300	240 M 07	CF 9 SMn 36	–	F.2113 – 12 SMn 35	1215	–
1.0737	9 SMnPb 36	–	S 300 Pb	–	CF 9 SMnPb 36	1926	F.2114 – 12 SMnPb 35	12 L14	–
<b>1.2.4 Kaltfließpressstähle – Cold flow press steels – Aciers pour extrusion à froid – Acciai estrusi a freddo</b>									
1.1132	Cq 15	C 15 KD	C 15 C	C15E2C	C15E2C	C15E2C	–	–	SWRCH15K
1.1152	Cq 22	C 21 KD	C 22 C	C20E2C	C20E2C	C20E2C	–	–	SWRCH20K
1.1172	Cq 35	C 35 KD	C 35 C	–	–	–	–	–	–
1.1192	Cq 45	C 45 KD	C 45 C	C45EC	C45EC	C45EC	–	–	SWRCH45K
<b>1.3 Legierte Stähle (Rm &lt; 800 N/mm²) – Alloyed steel (tensile strength &lt; 800 N/mm²) – Aciers alliés (résistance &lt; 800 N/mm²) – Acciai legati (resistenza &lt; 800 N/mm²)</b>									
<b>1.3.1 Kaltzähle Baustähle – Cold-tough structural steels – Aciers alliés pour l'usinage à froid – Acciai per l'uso a freddo</b>									
1.1169	20 Mn 6	–	–	–	–	–	–	–	–
1.4311	X 2 CrNiN 18 10	X 2 CrNiN 18 10	Z 2 CN 18-10 AZ	304 S 62	X 2 CrNiN 18 11	2371	F.3541	304 LN	SUS 304 LN
1.4406	X 2 CrNiMoN 17 12 2	X 3 CrNiMoN 17 12 2	Z 3 CND 17-12 AZ	316 S 61	X 2 CrNiMoN 17 12	2375	F.3543	316 LN	SUS 316 LN
1.5622	14 Ni 6	–	16 N 6	–	14 Ni 6	–	F.2641 – 15 Ni 6	A 350 – LF 5	–
1.5633	24 Ni 8	–	22 N 8	–	–	–	–	–	–
1.7219	26 CrMo 4	–	25 CD 4 S	–	–	–	–	–	–

W-Nr.	DIN (DE)	EN (EU)	NF A (FR)	BS (GB)	UNI (IT)	SS (SE)	UNE (ES)	SAE/ASTM (US)	JIS (JP)
<b>1.3.2 Warmfeste Baustähle – Heat resistant structural steels – Aciers réfractaires – Acciai resistenti al calore</b>									
1.0482	19 Mn 5	P 335 GH	A 52 CP; AP; FP	224-460	–	2101	A 47 RB II	A 537	–
1.4922	X 20 CrMoV 12 1	–	X 20 CrMoV 11 1	762	X 20 CrMoNi 12 01 KG	2317	–	–	–
1.5404	21 MoV 53	–	–	–	–	–	–	–	–
1.5406	17 MoV 84	–	–	–	–	–	–	–	–
1.7337	16 CrMo 4 4	–	15 CD 4.5	1501 620 Gr. 27	14 CrMo 4 5	2216	–	A 387 12 Cl.2	–
1.8070	21 CrMoV 5 11	–	–	–	–	–	–	–	–
<b>1.3.3 Nitrierstähle – Nitriding alloy steels – Aciers de nitruration – Acciai da nitrurazione</b>									
1.8504	34 CrAl 6	–	–	–	–	–	–	–	–
1.8506	34 CrAlS 5	–	–	–	–	–	–	–	–
1.8515	31 CrMo 12	31 CrMo 12	30 CD 12	722 M 24	31 CrMo 12	2240	F.1712 – 31 CrMo 12	–	–
1.8519	31 CrMoV 9	–	40 CAD 6.12	–	–	–	–	–	–
1.8550	34 CrAlNi 7	–	–	–	–	–	–	–	–
<b>1.3.4 Vergütungsstähle – Heat-treatable steels – Aciers d'amélioration – Acciai da bonifica</b>									
1.1133	20 Mn 5	–	20 M 5	120 M 19	G 22 Mn 3	1410	F-1515	1022; 1518	SMnC 420
1.1157	40 Mn 4	–	35 M 5, 40 M 5	150 M 36	–	–	–	1039	–
1.1170	28 Mn 6	–	20 M 5	150 M 28	C 28 Mn	–	–	1330	SCMn 1
1.7220	34 CrMo 4	34 CrMo 4	34 CD 4	708 A 37	35 CrMo 4	2234	F.8231-AM – 34 CrMo 4	4137; 4135	SCM 432; SCM 435
1.7225	42 CrMo 4	42 CrMo 4	42 CD 4; 42 C 4 TS	708 M 40	42 CrMo 4	2244	F.8232 – 42 CrMo 4	4140; 4142	SCM 440
1.7228	50 CrMo 4	50 CrMo 4	–	708 A 47	50 CrMo 4	–	50 CrMo 4	4150	SCM 445 (H)
<b>1.3.5 Stahlguss – Cast steel – Fonte d'acier – Acciaio fuso</b>									
1.5919	GS-15 CrNi 6	–	16 NC 6	S 107	16 CrNi 4	–	–	–	–
1.7218	GS-25 CrMo 4	25 CrMo 4	25 CD 4	708 A 25; CDS 110	25 CrMo 4	2225	F.8330-AM – 25 CrMo 4	4130	SCM 420; SCM 430
1.7220	GS-34 CrMo 4	34 CrMo 4	34 CD 4	708 A 37	35 CrMo 4	2234	F.8231-AM – 34 CrMo 4	4137; 4135	SCM 432; SCM 435
1.7379	GS-18 CrMo 9 10	–	–	–	–	–	–	–	–
<b>1.4 Legierte, vergütete Stähle (Rm 800 – 1200 N/mm<sup>2</sup>) – Alloyed, Pre hardened steels (tensile strength 800 – 1200 N/mm<sup>2</sup>) – Aciers alliés, améliorés (résistance 800-1200 N/mm<sup>2</sup>) – Acciaio legato , pre trattato (resistenza 800 – 1200 N/mm<sup>2</sup>)</b>									
<b>Legierte, vergütete Stähle (kurzspanend) – Alloyed, Pre hardened steels (short chipping) – Aciers alliés, durété entre (laitons) – Acciaio legato , pre trattato a truciolo corto</b>									
<b>1.4.1 Vergütungsstähle – Heat-treatable steels – Aciers d'amélioration – Acciai da bonifica</b>									
1.1133	20 Mn 5	–	20 M 5	120 M 19	G 22 Mn 3	1410	F-1515	1022; 1518	SMnC 420
1.1157	40 Mn 4 V	–	35 M 5, 40 M 5	150 M 36	–	–	–	1039	–
1.1170	28 Mn 6 V	–	35 M 5, 20 M 5	150 M 28	C 28 Mn	–	–	1330	SMn 433
1.7218	25 CrMo 4	25 CrMo 4	25 CD 4	708 A 25	25 CrMo 4	2225	F.8330-AM – 25 CrMo 4	4130	SCM 420; SCM 430
<b>1.4.2 Wälzlagerstähle – Roller and ball bearing steels – Aciers laminés – Acciai per cuscinetti</b>									
1.3501	100 Cr 2 (W1)	–	–	–	–	–	–	–	–
1.3503	105 Cr 4 (W2)	–	–	–	–	–	–	E 51100	–
1.3505	100 Cr 6 (W3)	100 Cr 6	100 C 6; 20 NCD 2	534 A 99	100 Cr 6	2258	F.1310 – 100 Cr 6	52100	SUJ 2, SUJ 4
1.3520	100 CrMn 6 (W4)	100 CrMn 6	100 CM 6	–	–	–	100 CrMn 6	A 485/2	SUJ 3
1.3543	X 102 CrMo 17	–	–	–	X 105 CrMo 17	–	X 100 CrMo 17	–	–
<b>1.4.3 Federstähle – Spring steels – Aciers à ressort – Acciai per molle</b>									
1.5022	38 Si 6	–	–	–	–	–	–	–	–
1.5024	46 Si 7	–	–	–	–	–	–	–	–
1.5025	51 Si 7	–	–	–	51 Si 7	–	–	–	–
1.5142	60 SiMn 5	–	–	–	–	–	–	–	–
1.7103	67 SiCr 5	–	60 CS 7	–	67 SiCr 5	–	–	–	–
1.7701	51 CrMoV 4	–	51 CDV 4	–	51 CrMoV 4	–	–	–	–
<b>1.4.4 Verschleißfeste Stähle – Wear resisting steels – Aciers résistant à l'usure – Acciai resistenti all'usura</b>									
1.3401	X 120 Mn 12	–	Z 120 M 12	BW 10	X G 120 Mn 12	2183	F.82551-AM – X 120 Mn 12	A 128 75	SCMnH 1
–	HARDOX 400	–	–	–	–	–	–	–	–
<b>Legierte, vergütete Stähle (langspanend) – Alloyed, Pre hardened steels (long chipping) – Aciers alliés, durété entre (à copeaux longs) – Acciaio legato , pre trattato a truciolo lungo</b>									
<b>1.4.5 Vergütungsstähle – Heat-treatable steels – Aciers d'amélioration – Acciai da bonifica</b>									
1.7220	34 CrMo 4	34 CrMo 4	34 CD 4	708 A 37	35 CrMo 4	2234	F.8231-AM – 34 CrMo 4	4137; 4135	SCM 432; SCM 435
1.7225	42 CrMo 4	42 CrMo 4	42 CD 4; 42 C 4 TS	708 M 40	42 CrMo 4	2244	F.8232 – 42 CrMo 4	4140; 4142	SCM 440
1.7228	50 CrMo 4	50 CrMo 4	–	708 A 47	50 CrMo 4	–	50 CrMo 4	4150	SCM 445 (H)
<b>1.4.6 Einsatzstähle – Cementation steels – Aciers de cémentation – Acciai da cementazione</b>									
1.7131	16 MnCr 5 (EC 80)	16 MnCr 5	16 MC 5; 15 D 3	527 M 17	16 MnCr 5	2511	F.1515 – 16 MnCr 5	5115	SCr 415
1.7147	20 MnCr 5	–	20 MC 5	–	20 MnCr 5	2523	F.150.D	5120	SMnC 420 (H)
1.7321	20 MoCr 4	20 MoCr 4	–	–	16 NiCrMo 2	2506	–	8620	SNCM 220
1.7325	25 MoCr 4	–	–	–	20 NiCrMo 2	–	–	8625	–
1.5919	15 CrNi 6	–	16 NC 6	S 107	16 CrNi 4	–	–	–	–
<b>1.4.7 Nitrierstähle – Nitriding alloy steels – Aciers de nitruration – Acciai da nitrurazione</b>									
1.8504	34 CrAl 6	–	–	–	–	–	–	–	–
1.8507	34 CrAlMo 5	34 CrAlMo 5	30 CAD 6.12	905 M 31	34 CrAlMo 7	–	F.1741 – 34 CrAlMo 5	A 355 Cl. D	–
1.8509	41 CrAlMo 7	41 CrAlMo 7	40 CAD 6.12; Z 8 C 13	905 M 39	41 CrAlMo 7	2940	F.1740 – 41 CrAlMo 7	A 355 Cl. A	SACM 645
1.8515	31 CrMo 12	31 CrMo 12	30 CD 12	722 M 24	31 CrMo12	2240	F.1712 – 31 CrMo 12	–	–
1.8550	34 CrAlNi 7	34 CrAlNi 7	–	–	–	–	–	A 355 Cl. C	–
<b>1.4.8 Feinkornbaustähle – Fine-grain structural steels – Aciers frittés – Acciai a grana fina</b>									
1.8931	SfE 690 V	–	–	–	–	–	–	–	–
1.8941	SfE 960 V	–	–	–	–	–	–	–	–









W-Nr.	DIN (DE)	EN (EU)	NF A (FR)	BS (GB)	UNI (IT)	SS (SE)	UNE (ES)	SAE/ASTM (US)	JIS (JP)
<b>1.5 Werkzeugstähle (Rm &lt; 1300 N/mm<sup>2</sup>) – Tool steels (tensile strength &lt; 1300 N/mm<sup>2</sup>) – Aciers à outils (résistance &lt; 1300 N/mm<sup>2</sup>) – Acciai per utensili (resistenza &lt; 1300 N/mm<sup>2</sup>)</b>									
<b>Werkzeugstähle (kurzspanend) – Tool steels (short shipping) – Aciers à outils (laitons) – Acciai per utensili a truciolo corto</b>									
<b>1.5.1 Unlegierte Werkzeugstähle – Unalloyed tool steels – Aciers à outils non alliés – Acciai per utensili, non legati</b>									
1.1520	C 70 W1	C 70 U	–	–	–	–	–	–	–
1.1525	C 80 W1	C 80 U	Y190; Y180	–	C 80 KU	–	–	W108	–
1.1545	C 105 W1	C 105 U	Y 105	B W 1 A	C 100 KU	1880	F.5118	W 110	–
1.1554	C 110 W	C 110 U	–	1407	–	–	–	–	–
1.1730	C 45 W	C 45 U	Y 3 42	En 43 B	–	–	F.114	1045	–
1.1740	C 60 W	C 60 U	Y 3 55	–	–	–	–	–	SK 7
1.1744	C 67 W	–	Y 1 70	–	–	–	F.512	–	–
1.1820	C 55 W	–	–	–	–	–	–	–	–
<b>1.5.2 Werkzeugstähle für Kaltarbeit – Tool steels for cold work – Aciers pour travail à froid – Acciai per lavorazioni a freddo</b>									
1.2080	X 210 Cr 12	X 210 Cr 12	Z 200 C 12	BD 3	X 210 Cr 13 KU	2710	F.5212 – X 210 Cr 12	D 3	SKD 1
1.2127	105 MnCr 4	–	–	–	100 CrMn 4 KU	–	–	–	SUJ 3
1.2201	X 165 CrV 12	–	–	–	–	–	–	–	–
1.2303	100 CrMo 5	–	–	–	–	–	–	L 7	–
1.2363	X 100 CrMoV 5 1	–	Z 100 CDV 5	BA 2	X 100 CrMoV 5 1 KU	2260	F.5227 – X 100 CrMoV 5	A 2	SKD 12
1.2379	X155 CrMoV 12 1	–	Z 160 CDV 12	BD2	X 155 CrMoV 12 1 KU	2310	F.5211 – X 155 CrMoV 12-1	D 2	–
1.2436	X 210 CrW 12	X 210 CrW 12	Z 200 CD 12	BD 6	X 215 CrW 12 1 KU	2312	F.5213 – X 210 CrW 12	D 4 (D 6)	SKD 2
1.2601	X 165 CrMoV 12	X 165 CrMoV 12	–	–	X 165 CrMoV 12 KU	2310	F.5211 – X 160 CrMoV 12	–	–
1.2842	90 MnCrV 8	–	90 MV 8	BO 2	90 MnVCr 8 KU	–	–	O 2	–
1.2880	X 165 CrCoMo 12	–	–	–	–	–	–	–	–
1.2884	X 210 CrCoW 12	–	–	–	–	–	–	–	–
–	VANADIS 4	–	–	–	–	–	–	–	–
–	VANADIS 10	–	–	–	–	–	–	–	–
–	CPM 10 V	–	–	–	–	–	–	–	–
–	TOOLOX 33	–	–	–	–	–	–	–	–
<b>1.5.3 Schnellarbeitsstähle – High speed steels – Aciers rapides – Acciai rapidi</b>									
1.3243	S 6-5-2-5	(HS 6-5-2-5)	785 WD; KCV 06-05-05-04-02	–	HS 6-5-2-5	2723	F.5613 6-5-2-5	M 35	SKH 55
1.3343	S 6-5-2	HS 6-5-2	Z 85 WDCV 06-05-04-02	BM 2	HS 6-5-2	2722	F.5603 6-5-2	M 2	SKH 9; SKH 51
1.3344	S 6-5-3	HS 6-5-3	Z 120 WDCV 06-05-04-03	BM 4	HS 6-5-3	–	F.5605 6-5-3	M 3 Cl.2	SKH 52; SKH 53
1.3346	S 2-9-1	HS 1-8-1	Z 85 DCWV 08-04-02-01	BM 1	HS 1-8-1	–	–	H 41; M 1	–
1.3348	S 2-9-2	HS 2-9-2	Z 100 WCWV 09-04-02-02	–	HS 2-9-2	2782	F.5607 2-9-2	M 7	–
–	ASP 23	–	–	–	–	–	–	–	–
–	ASP 30	–	–	–	–	–	–	–	–
–	ASP 60	–	–	–	–	–	–	–	–
–	CPM REX M4	–	–	–	–	–	–	–	–
<b>Werkzeugstähle (langspanend) – Tool steels (long shipping) – Aciers à outils (à copeaux longs) – Acciai per utensili a truciolo lungo</b>									
<b>1.5.4 Werkzeugstähle für Kaltarbeit – Tool steels for cold work – Aciers pour travail à froid – Acciai per lavorazioni a freddo</b>									
1.2083	X 42Cr 13	X 42 Cr 13	Z 40 C 14	–	X 41 Cr 13 KU	–	–	–	SUS 420 J 2
1.2312	40 CrMnMoS 8 6	–	–	–	–	–	X 210 CrW 12	P 20 + 1	–
1.2316	X 36CrMo 17	X 36 CrMo 17	–	–	X 38 CrMo 16 1 KU	–	X 38 CrMo 16	–	–
<b>1.5.5 Werkzeugstähle für Warmarbeit – Tool steels for hot work – Aciers pour travail à chaud – Acciai per lavorazioni a caldo</b>									
1.2309	65 MnCrMo 4	–	–	–	–	–	–	–	–
1.2311	40 CrMnMo 7	–	–	–	–	–	–	–	–
1.2343	X 38CrMoV 5 1	X 38 CrMoV 5 1	Z 38 CDV 5	BH 11	X 37 CrMoV 5 1 KU	–	F.5317 – X 37 CrMoV 5	H 11	SKD 6
1.2344	X 40 CrMoV 5 1	–	Z 40 CDV 5	BH 13	X 40 CrMoV 5 1 KU	2242	F.5318 – X 40 CrMoV 5	H 13	SKD 61
1.2367	X 38 CrMoV 5 3	–	–	–	–	–	–	–	–
1.2622	X 60 WCrMoV 9 4	–	–	–	–	–	–	–	–
1.2678	X 45 CrCoW 5 5 5	–	–	–	–	–	–	–	–
1.2731	X 50 NiCrWV 13 13	–	–	–	–	–	–	–	–
1.2767	X 45 NiCrMo 4	–	–	–	42 NiCrMo 15 7	–	–	–	–
1.2889	X 45 CoCrMoV 5 5 3	–	–	–	–	–	–	–	–
1.2889	X 45 CoCrMoV 5 5 3	–	–	–	–	–	–	–	–
<b>1.6 Rost-, säure- und hitzebeständige Stähle – Stainless, acid- and heatproof steels – Aciers inoxydables, résistants aux acides et aciers réfractaires – Acciai inossidabili – resistenti agli acidi e refrattari</b>									
<b>1.6.1 Rostfrei, geschwefelt – Stainless steels, sulfur – Inox, soufrés – Acciaio inox sulfureo</b>									
1.4104	X 12 CrMoS 17	X 14 CrMoS 17	Z 10 CF 17; Z 6 CT 12	420 S 37; 441 S 29	X 12 CrMoS 17	2383	F.3117 – X 10 CrS 17	430 F	SUS 430 F
1.4105	X 4 CrMoS 18	X 6 CrMoS 17	Z 6 CDF 18-02	X 6 CrMoS 17	X 6 CrMoS 17	–	–	430 FR	–
1.4305	X 10 CrNiS 18 9	X 10 CrNiS 18 9	Z 10 CNF 18-09	303 S 31	X 10 CrNiS 18 9	2346	F.3508 – X 10 CrNiS 18-09	303	SUS 303
1.4305	X 10 CrNiS 18 9	X 10 CrNiS 18 9	Z 10 CNF 18-09	303 S 31	X 10 CrNiS 18 9	2346	F.3508 – X 10 CrNiS 18-09	303	SUS 303
<b>1.6.2 Rostfrei, austenitisch – Austenitic stainless steels – Acier inoxydable, austénitique – Acciaio inox austenitico</b>									
1.4300	X 12 CrNi 18 8	–	–	–	302 S 25	–	–	–	–
1.4301	X 5 CrNi 18 10	X 5 CrNi 18 10	Z 6 CN 18-09	304 S 15	X 5 CrNi 18 10	2332	F.3504 – X 5 CrNi 18-10	304; 304 H	SUS 304
1.4308	X 6 CrNi 18 9	X 6 CrNi 18 9	Z 6 CN 18-10 M	304 C 15	GX 5 CrNi 19-10	2333	–	3042	SCS 13
1.3956	X 8 CrNi 18 12	X 8 CrNi 18 12	–	305 S 19	X 8CrNi 19 10	–	F.3503 – X 8 CrNi 19-10	305	SUS 305
1.4312	G-X 10 CrNi 18 8	G-X 10 CrNi 18 8	Z 10 CN 18-09 M	302 C 25	–	–	–	–	SCS 12
1.4406	X 2 CrNiMoN 17 12 2	X 3 CrNiMoN 17 12 2	Z 3 CND 17-12 AZ	316 S 61	X 2 CrNiMoN 17 12	2375	F.3543	316 LN	SUS 316 LN
1.4408	X 6 CrNiMo 18 10	X 6 CrNiMo 18 10	GX 5 CrNiMo 19-11-2	316 C 16; 340 C 15	GX 5 CrNiMo 19-11-2	2343	F.8414-AM – X 7 CrNiMo 20-10	CF-8 M	SCS 14
1.4410	X 3 CrNiMoN 25 7 4	X 3 CrNiMoN 25 7 4	Z 5 CND 20-10 M	–	–	–	–	S 32750	–
1.4433	X 2 CrNiMo 18 15	–	–	–	–	–	–	–	–
1.4435	X 2 CrNiMo 18 14 3	X 2 CrNiMo 18 16	Z 3 CND 18-14-03	316 S 13	X 2 CrNiMo 18 14 3	2353	F.3533-Z – 2 CrNiMo 17-12-03	316 L	SUS 316 L / SCS 16
1.4536	G-X 2 NiCrMoCuN 25 20	GX 2 NiCrMoCuN 25 20	–	–	–	–	–	–	–
1.4541	X 6 CrNiTi 18 10	X 6 CrNiTi 18 10	Z 6 CNT 18-10	321 S 31	X 6 CrNiTi 18 10	2337	F.3523 – X 7 CrNiTi 18-11	321	SUS 321
1.4550	G-X 6 CrNiNb 18 10	G-X 6 CrNiNb 18 10	Z 6 CNb 18-10	347 S 31	Z 6 CrNiNb 18-10	2338	F.3552 – X 7 CrNiNb 18-11	347	–
1.4571	X 6 CrNiMoTi 17 12 2	X 6 CrNiMoTi 17 12 2	Z 6 CNDT 17-12-02	320 S 31	X 6 CrNiMoTi 17 12	2350	F.3535	316 Ti	SUS 316 Ti
1.4573	X 10 CrNiMoTi 18 12	–	–	320 S 33	X 6 CrNiMoTi 17 13	–	–	316 Ti	–
1.4581	G-X 5 CrNiMoNb 18 10	–	Z 4 CNDNb 18-12 M	318 C 17	GX 6 CrMoNb 20 11	–	–	–	SCS 22

W-Nr.	DIN (DE)	EN (EU)	NF A (FR)	BS (GB)	UNI (IT)	SS (SE)	UNE (ES)	SAE/ASTM (US)	JIS (JP)
<b>1.6.3 Rostfrei, ferritisch – Ferritic stainless steels – Acier inoxydable, ferritique – Acciaio inox ferritico</b>									
1.4000	X 6 Cr 13	X 6 Cr 13	Z 6 C 13	403 S 17	X 6 Cr 13	2301	F.3110 – X 6 Cr 13	403	SUS 403
1.4002	X 6 CrAl 13	X 6 CrAl 13	Z 6 CA 13	405 S 17	X 6 CrAl 13	2302	F.3111 – X 6 CrAl 13	405	SUS 405
1.4008	G-X 8 CrNi 13	(G-X 7 CrNiMo 12-1)	Z 12 CN 13 M	410 C 21	GX 12 Cr 13	-	-	-	SCS 1
1.4016	X 6 Cr 17	X 8 Cr 17	Z 8 C 17	430 S 17	X 8 Cr 17	2320	F.3113 – X 8 Cr 17	430	SUS 430
1.4027	G-X 20 Cr 14	-	Z 20 C 13 M	420 C 29	-	-	-	-	SCS 2
1.4059	G-X 22 CrNi 17	-	Z 20 CN 17-02 M	ANC 2	-	-	-	-	-
1.4113	X 6 CrMo 17	(X 8 CrMo 17)	Z 8 CD 17-01	434 S 17	X 8 CrMo 17	2325	-	434	SUS 434
1.4510	X 6 CrTi 17	-	-	-	X 6 CrTi 17	-	F.3114 – X 8 CrTi 17	430 Ti	SUS 430 LX
1.4511	X 6 CrNb 17	-	Z 4 Cnb 17	-	X 6 CrNb 17	-	-	430 Nb	SUS 430 LX
1.4512	X 5 CrTi 12	-	Z 6 CT 12	409 S 19	X 6 CrTi 12	-	-	409	SUH 409
1.4528	X 105 CrCoMo 18 2	-	-	-	-	-	-	-	-
1.4712	X 10 CrSi 6	-	-	-	-	-	-	-	-
1.4722	X 10 CrSi 13	-	-	-	-	-	-	-	-
1.4762	X 10 CrAl 24	-	Z 10 CAS 24	-	X 16 Cr 26	2322	F.3154 – X 10 CrAl 24	446	SUH 446
<b>1.6.4 Rostfrei, ferritisch-austenitisch – Ferritic-austenitic stainless steels – Acier inoxydable, ferritique-austénitique – Acciaio inox ferritico-austenitico</b>									
1.4460	X 8 CrNiMo 27 5	-	Z 5 CND 27-05 AZ	-	-	2324	F.3309 – X 8 CrNiMo 27-05	329	SUS 329 J 1
1.4582	X 4 CrNiMoNb 25 7	-	-	-	-	-	-	-	-
1.4821	X 20 CrNiSi 25 4	-	Z 20 CNS 25-04	-	X 20 CrNiSi 25 4	-	X 20 CrNiSi 25-04	-	-
<b>1.6.5 Rostfrei, martensitisch – Martensitic stainless steels – Aciers inoxydables martensitiques – Acciaio inox martensitico</b>									
1.4005	X 12 CrS 13	X 12 CrS 13	Z 12 CF 13	416 S 21	X 12 CrS 13	2380	F.3411 – X 12 CrS 13	416	SUS 416
1.4006	X 10 Cr 13	X 10 Cr 13	Z 10 C 14	410 S 21	X 12 Cr 13	2302	F.3401 – X 12 Cr 13	410	SUS 410
1.4021	X 20 Cr 13	X 20 Cr 13	Z 20 C 13	420 S 37	X 20 Cr 13	2303	F.3402 – X 20 Cr 13	420	SUS 420 J 1
1.4024	X 15 Cr 13	X 15 Cr 13	-	420 S 29	X 15 Cr 13	-	-	410	SUS 410 J 1
1.4028	X 30 Cr 13	X 30 Cr 13	Z 30 C 13	420 S 45	X 30 Cr 13	2304	F.3403 – X 30 Cr 13	420	SUS 420 J 2
1.4034	X 46 Cr 13	X 46 Cr 13	Z 44 C 14	(Z20 S45)	X 40 Cr 14	-	F.3405 – X 45 Cr 13	-	-
1.4057	X 20 CrNi 17 2	X 19 CrNi 17 2	Z 15 CN 16-02	431 S 29	X 16 CrNi 16	2321	F.3427 – X 15 CrNi 16	431	SUS 431
1.4106	X 10 CrMo 13	-	X 2 CrMoSiS 18-2-1	-	-	-	-	-	-
1.4112	X 90 CrMoV 18	-	X 89 CrMoV 18-1	X 89 CrMoV 18	X 89 CrMoV 18	-	-	440 B	SUS 440 B
1.4116	X 45 CrMoV 15	-	Z 50 CD 15	X 50 CrMoV 15	X 50 CrMoV 16	-	X 45 CrMoV 15	-	-
1.4138	G-X 120 CrMo 29 2	-	-	-	-	-	-	-	-
<b>1.6.6 Hitzebeständige Stähle – Heat resistant steels – Aciers réfractaires – Acciai refrattari</b>									
1.4710	G-X 30 CrSi 6	-	-	-	-	-	-	-	-
1.4718	X 45 CrSi 9 3	X 45 CrSi 8	Z 45 CS 9	401 S 45	X 45 CrSi 8	-	F.3220 – X 4 CrSi 09-03	HNV 3; HW 3; S 65007	SUH 1
1.4729	G-X 40 CrSi 13	-	-	-	G X 35 Cr 13	-	-	-	SCH 1
1.4747	X 80 CrNiSi 20	-	Z 80 CSN 20-02	443 S 65	X 80 CrSiNi 20	-	F.3222 – X 80 CrSiNi 20-02	HNV 6	SUH 4
1.4825	G-X 25 CrNiSi 18 9	-	-	-	-	-	-	-	-
1.4848	G-X 40 CrNiSi 25 20	-	-	310 C 40	GX 40 CrNi 26 20	-	F.8452 – AM	310 S	SCH 21
<b>2 Gusseisen – Cast iron – Fontes – Ghise</b>									
<b>2.1 Gusseisen mit Lamellengraphit (stark abrasiv) – Grey cast iron – Fonte grise – Ghisa grigia</b>									
0.6010	GG-10	GJL-100	Ft 10 B; FGL 100	Grade 100	G 10	0110-00	FG 10	A 48-20 B	FC 100
0.6015	GG-15	GJL-150	Ft 15 D; FGL 150	Grade 150	G 15; GS 370-17	0115-00	FG 15	A 48-25 B	FC 150
0.6020	GG-20	GJL-200	Ft 20 D; FGL 200	Grade 200	G 20	0120-00	FG 20	A 48-30 B	FC 200
0.6025	GG-25	GJL-250	Ft 25 D; FGL 250	Grade 250; 260	G 25	0125-00	FG 25	A 48-40 B	FC 250
<b>2.2 Gusseisen mit Lamellengraphit – Grey cast iron – Fonte grise – Ghisa grigia</b>									
0.6030	GG-30	GJL-300	Ft 30 D; FGL 300	Grade 300	G 30; GS 700-2	0130-00	FG 30	A 48-45 B	FC 300
0.6035	GG-35	GJL-350	Ft 35 D; FGL 350	Grade 350	G 35	0135-00	FG 35	A 48-50 B	FC 350
0.6040	GG-40	GJL-400	Ft 40 D; FGL 400	Grade 400	G 40; GMN 70	0140-00	FG 40	A 48-60 B	FC 400
<b>2.3 Kugelgraphitguss, Temperguss – Nodular cast iron, malleable cast iron – Fonte grise à graphite sphéroïdal – Ghisa sferoidale</b>									
0.7033	GGG-35.3	GJS-350-22	FGS 370-17	350/22 L 40	GMN 45	0717-15	-	-	-
0.7040	GGG-40	GJS-400-15	FGS 400-15	SNG 420 / 12	GS 400-12	0717-02	FGE 38-17	60-40-18	FCD 400
0.7043	GGG-40.3	GJS-400-18	FGS 370-17	SNG 370 / 17	GSO 42/17	0717-12	-	-	FCD 370
0.7050	GGG-50	GJS-500-7	FGS 500-7	SNG 500 / 7	GS 500-7	0727-02	FGE 50-7	65-45-12	FCD 500
0.7060	GGG-60	GJS-600-3	FGS 600-3	SNG 600 / 3	GS 600-3	0732-03	FGE 60-2	80-55-06	FCD 600
0.8035	GTW-35-04	GJMW-350-4	MB 35-7	W 340 / 3; W 35-04	W 35-04	-	Type B	-	FCMW 330
0.8040	GTW-40-05	GJMW-400-5	MB 40-10; MB 400-5	W 410 / 4; W 40-05	GMB 40 / W40-05	-	Type A	-	FCMW 370
0.8045	GTW-45-07	GJMW-450-7	MB 450-7	W 45-07	GMB 45 / W45-07	-	-	-	FCMWP 440
0.8055	GTW-55	-	-	-	GMB 55	-	-	-	-
0.8065	GTW-65	-	-	-	-	-	-	-	-
0.8135	GTS-35-10	GJMB-350-10	MN 350-10	B 340 / 12; B 35-12	P 35-10	0815-00	-	32510	FCMB 340
0.8145	GTS-45-06	GJMB-450-6	MN 450-6	P 440 / 7; P 45-06	GMN 55 / P45-06	0852-00	-	A220-40010	FCMP 440 / 490
0.8155	GTS-55-04	GJMB-550-4	MN 550-4 / MP 50-5	P 510 / 4; P 55-04	GMN 65 / P55-04	0854-00	-	A220-50005	FCMP 540
0.8165	GTS-65-02	GJMB-650-2	MN 650-3	P 570 / 3; P 65-02	GMN 70 / P65-02	0856-00 / 0858-00	-	A220-70003	FCMP 590
<b>2.4 Gußeisen mit Vermikulargraphit – Compacted graphite cast iron – Fonte vermiculaire – Ghisa vermicolare</b>									
-	GGV-30	EN-GJV-300	-	-	-	-	-	-	-
-	GGV-40	EN-GJV-400	-	-	-	-	-	-	-
<b>3 Kupfer / Kupferlegierungen – Copper / Copper alloys – Cuivre / Alliages de cuivre – Rame / leghe di Rame</b>									
<b>3.1 Kupfer (unlegiert, niedriglegiert) – Copper – Cuivre (non allié, faiblement allié) – Rame non e debolmente legato</b>									
2.0060	E-Cu 57	-	Cu-a 1; A 2	Cu-ETP-2 C 101	-	-	-	C 11000	-
2.0070	SE-Cu	-	Cu-c1	C 101	-	-	-	C 10300	-
2.0090	SF-Cu	-	Cu-b1	Cu-DHP C 106	-	-	-	C 12200	-
2.1356	CuMn 3	-	-	-	-	-	-	-	-
2.1522	CuSi 2 Mn	-	-	-	-	-	-	-	-
<b>3.2 Kupfer-Legierungen (kurzspanend) – Copper alloys (short chipping) – Alliages de cuivre à copeaux courts (laitons) – Leghe di Rame a truciolo corto</b>									
2.0360	CuZn 40 (Ms60)	-	CuZn 40 (Ms60)	CZ 109	OT 60	-	-	C 28000	-
2.0380	CuZn 39 Pb 2 (Ms58)	-	MS 58	CZ 120	OT 58	-	-	-	-
2.0410	CuZn 44 Pb 2 (Ms 56)	-	CuZn 44 Pb 2	CZ 130	OT 56	-	-	C 38500	-
2.0561	CuZn 40 Al 1	-	-	-	-	-	-	-	-
2.0580	CuZn 40 Mn 1 Pb	-	-	CZ 115	-	-	-	-	-
2.0771	CuNi 7 Zn 39 Mn 5 Pb 3	-	-	-	-	-	-	-	-

W-Nr.	DIN (DE)	EN (EU)	NF A (FR)	BS (GB)	UNI (IT)	SS (SE)	UNE (ES)	SAE/ASTM (US)	JIS (JP)
2.1050	G-CuSn 10 Zn (Rg 10)	-	-	G 1	-	-	-	C 90500	-
2.1086	G-CuSn 10	-	-	CT 1	-	-	-	C 90250	-
2.1093	G-CuSn 6 ZnNi	-	-	LG 4	-	-	-	C 92410	-
2.1096	G-CuSn 5 ZnPb (Rg 5)	-	CuPb 5 Sn 5 Zn 5	LG 2	-	-	-	C 83600	-
<b>3.3 Kupferlegierungen (langspannend) – Copper alloys (long chipping) – Alliages de cuivre (à copeaux longs) – Leghe di Rame a truciolo lungo</b>									
2.0250	CuZn 20 (Ms80)	-	CuZn 20	CZ 103	OT 80	-	-	C 24000	-
2.0265	CuZn 30 (Ms70)	-	CuZn 30	CZ 106	OT 70	-	-	C 26000	-
2.0321	CuZn 37	-	CuZn 37	CZ 108	C 2720	-	-	C 27400	-
2.0335	CuZn 36 (Ms63)	-	CuZn 36	-	OT 63	-	-	C 27000	-
2.1020	CuSn 6	-	-	-	-	-	-	-	-
2.1030	CuSn 8	-	-	-	-	-	-	-	-
2.1080	CuSn 6 Zn 6	-	-	-	-	-	-	-	-
2.1245	CuBe 1,7	-	CuBe 1,7	CB 101	-	-	-	C 17000	-
2.1247	CuBe 2	-	CuBe 1,9	-	-	-	-	C 17200	-
2.1293	CuCrZr	-	UC 1 Zr	CC 102	-	-	-	C 18100	-
2.1525	CuSi 3 Mn	-	-	-	-	-	-	-	-
<b>3.4 Kupfer-Sonderlegierungen (&lt; 200 HB) – Copper alloys (&lt; 200 HB) – Alliages de cuivre (&lt; 200 HB) – Leghe di Rame speciali (&lt; 200 HB)</b>									
2.0916	CuAl 5 (AlBz 5)	-	-	-	-	-	-	-	-
2.0932	CuAl 8 Fe 3 (AlBz 8 Fe)	-	CuAl 7 Fe 2	CA 106	-	-	-	C 61400	-
2.0966	CuAl 10 Ni 5 Fe 4	-	CuAl 9 Ni 5 Fe 3 Mn; U-A 10 N	CA 104	-	-	-	C 63200	-
2.1247	CuBe 2 Fe 40	-	CuBe 1,9	-	-	-	-	C 17200	-
-	AMPCO 8	-	-	-	-	-	-	-	-
-	AMPCO 12	-	-	-	-	-	-	-	-
-	AMPCO 15	-	-	-	-	-	-	-	-
-	AMPCO 16	-	-	-	-	-	-	-	-
<b>3.5 Kupfer-Sonderlegierungen (200 HB – 300 HB) – Copper alloys (200 HB – 300 HB) – Alliages de cuivre (200 – 300HB) – Leghe di Rame speciali (200 HB – 300 HB)</b>									
2.0978	CuAl 11 Ni 6 Fe 5	-	CuAl 11 Ni 6 Fe 5	-	-	-	-	-	-
2.1245	CuBe 1,7 F55	-	CuBe 1,7	CB 101	-	-	-	C 17000	-
-	AMPCO 18	-	-	-	-	-	-	-	-
-	AMPCO 20	-	-	-	-	-	-	-	-
<b>3.6 Kupfer-Sonderlegierungen (&gt; 300 HB) – Copper alloys (&gt; 300 HB) – Alliages de cuivre (&gt; 300 HB) – Leghe di Rame speciali (&gt; 300 HB)</b>									
2.1245	CuBe 1,7 F110	-	CuBe 1,7	CB 101	-	-	-	C 17000	-
2.1247	CuBe 2 F125	-	CuBe 1,9	-	-	-	-	C 17200	-
-	AMPCO 21	-	-	-	-	-	-	-	-
-	AMPCO 22	-	-	-	-	-	-	-	-
-	AMPCO 25	-	-	-	-	-	-	-	-
-	AMPCO 26	-	-	-	-	-	-	-	-
<b>4 Aluminium / Aluminiumlegierungen – Aluminium / Aluminium alloys – Aluminium / Alliages d'aluminium – Alluminio / Leghe di Alluminio</b>									
<b>4.1 Aluminium (unlegiert, niedriglegiert) – Aluminium – Aluminium (non allie-faiblement allié) – Alluminio non e debolmente legato</b>									
3.0250	Al 99,5 H	-	A 59050 C	1 B; L31 / 34 / 36	-	144007	L-3051	1050 A	-
3.0256	E-Al H	-	A 5 / L	1 E	-	144008	L-3052	1350 A	-
3.0280	Al 99,8 H	-	A 8	1 A	-	144004	L-3081	1080 A	-
3.3308	Al 99,9 Mg 0,5	-	A-9-G 0,5	-	-	-	-	-	-
<b>4.2 Aluminium-Legierungen (&lt; 0,5% Si) – Aluminium alloys (&lt; 0,5% Si) – Alliages d'aluminium (&lt; 0,5% Si) – Leghe di Alluminio (&lt; 0,5% Si)</b>									
3.0515	G-Al 99,5	-	3103	N 3	3568	144054	L 3811	3103	-
3.0516	S-AlMn	-	-	NG 3	-	144055	-	-	-
3.0525	AlMn 1 Mg 0,5	-	A – M 1 G 0,5	-	-	-	-	3005	A 3005
3.0615	AlMgSiPb	-	6262	-	-	-	L 3452	6012	-
3.1325	AlCuMg 1	AW-2017 A	A – U 4 G	H 14	3579	-	L-3120	2017 A	A 2017
3.1355	AlCuMg 2	AW-2024	A – U 4 G 1	2 L 98	3583	-	L-3140	2024	A 2024
3.1841	G-AlCu 4 Ti	-	-	2 L 91/92	3044	-	-	-	A C 1 A
3.3241	G-AlMg 3 Si	-	A-G 3 T	-	-	-	L 2341	511	-
3.3292	GD-AlMg 9	-	-	-	-	-	-	-	-
3.3315	AlMg 1	AW-6082	A – G 0,6	N 41	5764	144106	L-3350	5005 A	A 5005
3.3535	AlMg 3	-	A – G 3 M	N 5	3575	144133	L-3390	5754	-
3.4365	AlZnMgCu 1,5	-	A – Z 5 GU	2 L 95	3735	-	L-3710	7075	A 7075
<b>4.3 Aluminium-Legierungen (0,5% – 10% Si) – Aluminium alloys (0,5% – 10% Si) – Alliages d'aluminium (0,5% – 10% Si) – Leghe di Alluminio (0,5% – 10% Si)</b>									
3.2134	GD-AlSi 5 Cu 1 Mg	-	A – S 4 Gu	LM 16	3600	-	-	355,1	A C 4 D
3.2152	GD-AlSi 6 Cu 4	-	A – S 5 U	LM 4 – LM 22	-	4230	L-2660	319,2	-
3.2162	GD-AlSi 8 Cu 3	-	A – S 9 U 3	LM 24	-	4252	L-2630	380,1	-
3.2373	G-AlSi 9 Mg	-	A 7 – S 10 G	-	3051	4235	-	-	A C 4 A
<b>4.4 Aluminium-Legierungen (10% – 15% Si) – Aluminium alloys (10% – 15% Si) – Alliages d'aluminium (10% – 15% Si) – Leghe di Alluminio (10% – 15% Si)</b>									
3.2381	G-AlSi 10 Mg	-	A – S 10 G	LM 9	-	4253	L-2560	A 360	-
3.2383	G-AlSi 10 Mg (Cu)	-	A – S 10 UG	LM 9	-	4253	-	A 360,2	A D C 3
3.2581	G-AlSi 12	-	A – S 13	LM 6	4514	4261	L-2520	A 413,2	A C 3 A
3.2583	G-AlSi 12 (Cu)	-	A – S 12 U	LM 20	3048	4260	L-2530	A 413,1	A D C 1
3.2982	GD-AlSi 12 (Cu)	-	-	-	-	-	-	-	-
3.5106	G-MgAg 3 SE 2 Zr 1	MCMgRE 2 Ag 2 Zr	G-Ag 22,5	MAG 12	-	-	-	QE 22	-
3.5562	G-MgAl 6	-	-	-	-	-	-	-	-
3.5812	GD-MgAl 8 Zn 1	MCMgAl 8 Zn 1	G-A 9	MAG 1	AZ 81 hp	AZ 81 hp	AZ 81 hp	AZ 81	AZ 81 hp
3.5912	GD-MgAl 9 Zn 1	MCMgAl 9 Zn 1	G-A 9 Z 1	MAG 7	AZ 91 hp	-	-	AZ 91	-
<b>4.5 Aluminium-Legierungen (&gt; 15% Si) – Aluminium alloys (&gt; 15% Si) – Alliages d'aluminium (&gt; 15% Si) – Leghe di Alluminio (&gt; 15% Si)</b>									
-	G-AlSi 17 Cu 4	-	-	-	-	-	-	390	-
-	G-AlSi 21 CuNiMg	-	-	LM 28	-	-	-	-	-
-	G-AlSi 25 CuNiMg	-	-	LM 29	-	-	-	393	-

W-Nr.	DIN (DE)	EN (EU)	NF A (FR)	BS (GB)	UNI (IT)	SS (SE)	UNE (ES)	SAE/ASTM (US)	JIS (JP)
<b>5 Titan / Titanlegierungen – Titanium / Titanium alloys – Titane / Alliages de titane – Titanio / Leghe di Titanio</b>									
<b>5.1 Reintitan – Pure titanium – Titane pur – Titanio puro</b>									
3.7024.1 LN	Ti 99,5	-	T - 60	TA - 6 / 7 / 8 / 9	-	-	Ti - PO4	4901 / 21	-
3.7034.1 LN	Ti 99,7	-	T - 40	TA - 2 / 3 / 4 / 5	-	-	Ti - PO2	4941 / 42 / 51 / 4902	-
3.7055	Ti 99,4	-	T - 50	TA 3	-	-	-	R 50550	-
3.7064.1 LN	Ti 99,2	-	T - 60	2 TA - 6 / 7 / 8 / 9	-	-	-	-	-
<b>5.2 Titanlegierungen (Rm &lt; 900 N/mm²) – Titanium alloys (tensile strength &lt; 900 N/mm²) – Alliages de titane (résistance &lt; 900 N/mm²) – Leghe di Titanio (resistenza &lt; 900 N/mm²)</b>									
3.7114 LN	TiAl 5 Sn 2	-	-	-	-	-	-	-	-
3.7124 LN	TiCu 2	-	T - U 2	2 TA.21-24; TA.52-55 / 58	-	-	Ti - P11	-	-
3.7163 LN	TiAl 6 V 4	-	T - A 6 V	TA.10-13 / 28 / 56	-	-	Ti-P63	491128 / 35 / 54 / 65 / 67	-
3.7174 LN	TiAl 6 V 6 Sn 2	-	-	-	-	-	-	-	-
<b>5.3 Titanlegierungen (Rm 900 – 1500 N/mm²) – Titanium alloys (tensile strength 900 – 1500 N/mm²) – Alliages de titane (résistance 900 – 1500 N/mm²) – Leghe di Titanio (resistenza 900 – 1500 N/mm²)</b>									
3.7124 LN	TiCu 2	-	T - U 2	2 TA.21-24; TA.52-55 / 58	-	-	Ti - P11	-	-
3.7144 LN	TiAl 6 Sn 2 Zr 4 Mo 2	-	-	-	-	-	-	-	-
3.7154 LN	TiAl 6 Zr 5	-	T - A 6 ZD	TA.43 / 44	-	-	Ti - P67	-	-
3.7164 LN	TiAl 5 V 4	-	-	-	-	-	-	-	-
3.7164 LN	TiAl 6 V 4	-	T - A 6 V	TA.10-13 / 28 / 56	-	-	Ti-P63	491128 / 35 / 54 / 65 / 67	-
3.7174 LN	TiAl 6 V 6 Sn 2	-	-	-	-	-	-	-	-
3.7184 LN	TiAl 4 Mo 4 Sn 2	-	T - A 4 DE	TA.45-51 / 57	-	-	Ti - P68	-	-
<b>6 Nickel / Nickellegierungen – Nickel / Nickel alloys – Nickel / Alliages de nickel – Nickel / Leghe di Nickel</b>									
<b>6.1 Reinnickel – Pure nickel – Nickel pur – Nickel puro</b>									
2.1504 LN	NiAlBz	-	-	-	-	-	-	-	-
2.4042	Ni 99 CSi	-	-	-	-	-	-	-	-
2.4060	Ni 99,6	-	-	NA 46	-	-	-	-	-
2.4062	Ni 99,4 Fe	-	-	-	-	-	-	-	-
<b>6.2 Nickellegierungen (Rm &lt; 900 N/mm²) – Nickel alloys (tensile strength &lt; 900 N/mm²) – Alliages de Nickel (résistance &lt; 900 N/mm²) – Leghe di Nickel (resistenza &lt; 900 N/mm²)</b>									
2.4360	NiCu 30 Fe	Monel 400	NU 30	NA 13	-	-	-	N 04400	-
2.4374 LN	-	Monel 500	-	-	-	-	-	-	-
2.4617	NiMo 28	Hastelloy B 2	NiMo 28	NA 14	-	-	-	N 10665	-
2.4665	NiCr 22 Fe 18 Mo	Hastelloy X	NC 22 FeD	HR 6 / 204	-	MH-03	-	5536E	-
2.4812	-	Hastelloy C	-	-	-	-	-	-	-
2.4816	NiCr 15 Fe	Inconel 600	NC 15 Fe	NA 14	-	-	-	5540	NCF 600
2.4876	-	Inconel 800	-	-	-	-	-	-	-
2.4983	NiCr 18 Co 18 MoTi	Inconel 500	NCK 19 DAT	-	-	-	-	684	-
<b>6.3 Nickellegierungen (Rm 900 – 1500 N/mm²) – Nickel alloys (tensile strength 900 – 1500 N/mm²) – Alliages de Nickel (résistance 900 – 1500 N/mm²) – Leghe di Nickel (resistenza 900 – 1500 N/mm²)</b>									
2.4631	NiCr 20 TiAl	Nimonic 80A	NC 20 TA	HR 401	-	MH-07	-	-	NCF 80 A
2.4632	NiCr 20 Co 18 Ti	Nimonic 90	-	BA 19	-	-	-	-	-
2.4634	NiCo 20 Cr 15 MoAlTi	Nimonic 105	NCKD 20 ATV	HR 3 / 5007	-	MH-14	-	-	-
2.4662	-	Nimonic 901	Z 8 NCDT 42	MH 16	-	MH-16	-	5660 C	-
2.4668	NiCr 19 FeNbMo	Inconel 718	NC 19 Fe Nb	HR 8	-	MH-06	-	N 07718	NCF 718
2.4670 LN	G - NiCr 13 Al 6 MoNb	Nimocast 713	NC 13 AD	HC 203	-	MH-31	-	5391 A	-
2.4674 LN	NiCo 15 Cr 10 MoAlTi	Nimocast PK24	NK 15 CAT	HC 204	-	-	-	5397	-
2.4856	NiCr 22 Mo 9 Nb	Inconel 625	NC 22 FeDNB	NA 21	-	-	-	5581 / N 06625	NCF 625
2.6554	-	Waspaloy	-	-	-	-	-	-	-
<b>7 Kunststoffe – Plastics – Plastiques – Materie plastiche</b>									
<b>7.1 Thermoplaste – Thermoplastics – Thermoplastiques – Termoplastiche</b>									
-	Ultramit	-	-	-	-	-	-	-	-
-	Makralon	-	-	-	-	-	-	-	-
-	Hostalen	-	-	-	-	-	-	-	-
-	Degolan	-	-	-	-	-	-	-	-
-	Polystyrol	-	Polystyrène	Styrene	-	-	-	-	-
-	Hostaform	-	-	-	-	-	-	-	-
<b>7.2 Duroplaste und Presstoffe – Thermosetting polymers and pressed materials – Duroplastiques – Polimeri termoindurenti e materiali pressati</b>									
-	Bakelit	-	-	-	-	-	-	-	-
-	Pertinax	-	-	-	-	-	-	-	-
-	Ferrozell	-	-	-	-	-	-	-	-
-	Resopal	-	Résopal – Formica	Formica	-	-	-	-	-
-	Albanit	-	-	-	-	-	-	-	-
<b>7.3 Faserverstärkte Kunststoffe – Reinforced plastics – Matières synthétiques, renforcées par des fibres de verre – Plastiche rinforzate</b>									
-	CFK Kohlefaserverstärkt	-	-	-	-	-	-	-	-
-	GFK Glasfaserverstärkt	-	-	-	-	-	-	-	-
-	AFK Aramidfaserverstärkt	-	-	-	-	-	-	-	-
<b>8 Hartstoffe – Hardened materials – Matières dures (trempées) – Materiali duri</b>									
<b>8.1 Metallkeramiken – Metal ceramics – Matières dures, à base céramique – Materiali a base ceramica</b>									
-	Ferrotic	-	-	-	-	-	-	-	-
-	Ferrotitanit	-	-	-	-	-	-	-	-
<b>8.2 Gehärtete Stähle der Werkstoffgruppen 1.5 und 1.6.2 (50 – 65 HRC) – Hardened steels of groups 1.5 and 1.6.2 (50 – 65 HRC) – Aciers traités des groupes de matières 1.5 et 1.6.2 (50 – 65 HRC) – Acciai temprati del gruppo di materiali 1.5 e 1.6.2 (50-65 HRC)</b>									
<b>8.2.1 45 – 55 HRC</b>									
-	HARDOX 500	-	-	-	-	-	-	-	-
-	TOOLOX 44	-	-	-	-	-	-	-	-
<b>8.2.2 55 – 60 HRC</b>									
<b>8.2.3 60 – 65 HRC</b>									

<b>M</b>	Metrisches ISO-Regelgewinde DIN 13 ISO Metric coarse thread DIN 13 Filetage métrique ISO DIN 13 Metrica ISO-passo grosso DIN 13	<b>2B</b>	Toleranzklasse 2B Tolerance classe 2B Classe de tolérance 2B Tolleranza 2B	<b>DIN 6535 HA</b>	Schaftausführung DIN 6535 HA Shank design DIN 6535 HA Queue selon DIN 6535 HA Gambo DIN 6535 HA
<b>MF</b>	Metrisches ISO-Feingewinde DIN 13 ISO Metric fine thread DIN 13 Filetage métrique fin DIN 13 Metrica ISO-passo fine DIN 13	<b>HSSE-PM</b>	Pulverstahl Powder steel Acier fritté Acciaio sinterizzato	<b>DIN 6535 HB</b>	Schaftausführung DIN 6535 HB Shank design DIN 6535 HB Queue selon DIN 6535 HB Gambo DIN 6535 HB
<b>G</b>	Whitworth-Rohrgewinde DIN ISO 228 Whitworth pipe thread DIN ISO 228 Filetage Whitworth Gaz ISO 228 Whitworth-gas DIN ISO 228	<b>HSSE</b>	Hochleistungsschnellarbeitsstahl High speed steel Acier rapide Acciaio super rapido	<b>DIN 6535-HA</b> <b>DIN 6535-HB</b> <b>DIN 6535-HE</b>	Schaftausführung Shank design Queue selon Gambo
<b>UNC</b>	UNC-Gewinde ANSI-B 1.1 UNC thread ANSI-B 1.1 Filetage UNC ANSI-B 1.1 UNC-passo grosso ANSI-B 1.1	<b>VHM</b>	Vollhartmetall Solid carbide Carbure monobloc Metallo duro integrale	<b>DIN 13</b>	Metrisches ISO-Gewinde nach DIN 13 Metric ISO-thread according to DIN 13 Filetage métrique selon DIN 13 Filettatura Metrica ISO secondo DIN 13
<b>UNF</b>	UNF-Gewinde ANSI-B 1.1 UNF thread ANSI-B 1.1 Filetage UNF ANSI-B 1.1 UNF-passo fine ANSI-B 1.1	<b>WEXO</b>	Werknorm Internal standard Norme usine Norme interne	<b>DIN ISO 228</b>	Rohrgewinde nach DIN ISO 228 Pipe threads according to DIN ISO 228 Filetage pour tubes de Gaz selon DIN ISO 228 Filettatura Gas secondo DIN ISO 228
<b>Typ N</b>	Für gut spanbare Werkstoffe bis 800 N/mm <sup>2</sup> For well chipping materials up to 800 N/mm <sup>2</sup> Aciers mi durs < 800 N/mm <sup>2</sup> Per materiali vari fino a 800 N/mm <sup>2</sup>	<b>DIN 352</b>	Baumaße nach DIN 352 Dimensions acc. DIN 352 Dimensions selon DIN 352 Dimensioni sec. DIN 352	<b>ANSI B 1.1</b>	Unified-Gewinde nach ANSI B1.1 Unified threads according to ANSI B1.1 Filetage pas américains selon ANSI B 1.1 Filettatura Unified secondo ANSI B1.1
<b>Typ VA</b>	Für rostfreie Materialien und Stähle höherer Festigkeit For stainless materials and steels of higher tensile strength Pour matériaux inoxydables et aciers à haute résistance Per acciai inox e ad alta resistenza	<b>DIN 371</b>	Baumaße nach DIN 371 Dimensions acc. DIN 371 Dimensions selon DIN 371 Dimensioni sec. DIN 371	<b>≤60 HRC</b>	Härte des zu bearbeitenden Materials in Rockwell [HRC] The maximum hardness of the material to be machined is indicated in Rockwell [HRC] Dureté max. de la matière à usiner en HRC Massima durezza del materiale da lavorare in HRC
<b>Typ GG</b>	Für Grauguss For cast iron Pour fontes grises Per ghise	<b>DIN 374</b>	Baumaße nach DIN 374 Dimensions acc. DIN 374 Dimensions selon DIN 374 Dimensioni sec. DIN 374	<b>≤65 HRC</b>	Härte des zu bearbeitenden Materials in Rockwell [HRC] The maximum hardness of the material to be machined is indicated in Rockwell [HRC] Dureté max. de la matière à usiner en HRC Massima durezza del materiale da lavorare in HRC
<b>Typ AL</b>	Für Aluminium For aluminium Pour aluminium Per alluminio	<b>DIN 376</b>	Baumaße nach DIN 376 Dimensions acc. DIN 376 Dimensions selon DIN 376 Dimensioni sec. DIN 376	<b>B</b>	Anschnittform B, 3,5–5 Gewindegänge Chamfer form B, 3,5–5 threads Forme d'entrée B, 3,5–5 filets Imbocco forma B, 3,5–5 filetti
<b>Typ H</b>	Für kurzspanende, hochfeste Werkstoffe For short-chipping, tensile strength Pour matériaux à haute résistance Per materiali a resistenza alla trazione	<b>DIN 2174</b>	Baumaße nach DIN 2174 Dimensions acc. DIN 2174 Dimensions selon DIN 2174 Dimensioni sec. DIN 2174	<b>C</b>	Anschnittform C, 2–3 Gewindegänge Chamfer form C, 2–3 threads Forme d'entrée C, 2–3 filets Imbocco forma C, 2–3 filetti
<b>Typ HR</b>	Feine Schruppkordel-Verzahnung Fine pitch rounded profile-chip breaker Brise-copeaux à dents fines Rompitricciolo a dente fine	<b>DIN 2184-1</b>	Baumaße nach DIN 2184-1 Dimensions acc. DIN 2184-1 Dimensions selon DIN 2184-1 Dimensioni sec. DIN 2184-1		Drallwinkel 15 Grad Helix angle 15 degree Angle d'hélice 15 degrés Elica a 15°
<b>Typ UNI</b>	Für universellen Einsatz For universal use Pour utilisation universelle Per uso universale	<b>DIN 5156</b>	Baumaße nach DIN 5156 Dimensions acc. DIN 5156 Dimensions selon DIN 5156 Dimensioni sec. DIN 5156		Drallwinkel 40 Grad Helix angle 40 degree Angle d'hélice 40 degrés Elica a 40°
<b>AG</b>	Abgesetztes Gewinde Back tapered thread part Troncature arrière Rastremazione posteriore	<b>DIN 6527 L</b>	Baumaße nach DIN 6527 L Dimensions acc. DIN 6527 L Dimensions selon DIN 6527 L Dimensioni sec. DIN 6527 L		Drallwinkel 45 Grad Helix angle 45 degree Angle d'hélice 45 degrés Elica a 45°
<b>SN</b>	Schmiermuten Lubrication grooves Rainures de lubrification Gole di lubrificazione	<b>DIN 6527 K/L</b>	Baumaße nach DIN 6527 K/L Dimensions acc. DIN 6527 K/L Dimensions selon DIN 6527 K/L Dimensioni sec. DIN 6527 K/L		Drallwinkel Helix angle Angle d'hélice Angolo dell'elica
<b>ISO 2 6H</b>	Toleranzklasse ISO 2 6H Tolerance classe ISO 2 6H Classe de tolérance ISO 2 6H Tolleranza ISO2 6H	<b>DIN 6537 K</b>	Baumaße nach DIN 6537 K Dimensions acc. DIN 6537 K Dimensions selon DIN 6537 K Dimensioni sec. DIN 6537 K		Drallwinkel Helix angle Angle d'hélice Angolo dell'elica
<b>6HX</b>	Toleranzklasse 6HX Tolerance classe 6HX Classe de tolérance 6HX Tolleranza 6 HX	<b>DIN 6537 L</b>	Baumaße nach DIN 6537 L Dimensions acc. DIN 6537 L Dimensions selon DIN 6537 L Dimensioni sec. DIN 6537 L		Drallwinkel Helix angle Angle d'hélice Angolo dell'elica

	Drallwinkel Helix angle Angle d'hélice Angolo dell'elica		Bohrtiefe Drilling depth Profondeur de perçage Profondità di foratura		Titan-Aluminiumnitrid Spezial Titanium aluminium nitride Special Nitrure de titane-aluminium, spécial Nitruro di Titanio-Alluminio speciale
	Drallwinkel Helix angle Angle d'hélice Angolo dell'elica		Bohrtiefe (IKZ = mit Innenkühlung) Drilling depth (IKZ = with internal coolant) Profondeur de perçage (IKZ = Arrosage centralisé) Profondità di foratura (IKZ = Lubrificazione interna)		Werkstoffgruppe Classification of work materials Groupe de matières Gruppo materiali
	Flankenwinkel 55 Grad Flank angle 55 degree Angle de flanc 55 degrés Profilio a 55°		Bohrtiefe Drilling depth Profondeur de perçage Profondità di foratura		Anzahl Schneiden Number of teeth Nombre de dents Numero dei denti
	Flankenwinkel 60 Grad Flank angle 60 degree Angle de flanc 60 degrés Profilio a 60°		Bohrtiefe (IKZ = mit Innenkühlung) Drilling depth (IKZ = with internal coolant) Profondeur de perçage (IKZ = Arrosage centralisé) Profondità di foratura (IKZ = Lubrificazione interna)		Anzahl Schneiden Number of teeth Nombre de dents Numero dei denti
	Spitzenwinkel Point angle Angle de pointe Angolo di testa		Bohrtiefe (IKZ = mit Innenkühlung) Drilling depth (IKZ = with internal coolant) Profondeur de perçage (IKZ = Arrosage centralisé) Profondità di foratura (IKZ = Lubrificazione interna)		Anzahl Schneiden Number of teeth Nombre de dents Numero dei denti
	Spitzenwinkel Point angle Angle de pointe Angolo di testa		Bohrtiefe (IKZ = mit Innenkühlung) Drilling depth (IKZ = with internal coolant) Profondeur de perçage (IKZ = Arrosage centralisé) Profondità di foratura (IKZ = Lubrificazione interna)		Anzahl Schneiden Number of teeth Nombre de dents Numero dei denti
	Spitzenwinkel Point angle Angle de pointe Angolo di testa		Mögliche Vorschubrichtung Possible feed direction Direction des avances possibles Possibili direzioni di avanzamento		Anzahl Schneiden Number of teeth Nombre de dents Numero dei denti
	Spitzenwinkel Point angle Angle de pointe Angolo di testa		Mögliche Vorschubrichtung Possible feed direction Direction des avances possibles Possibili direzioni di avanzamento		Anzahl Schneiden Number of teeth Nombre de dents Numero dei denti
	Für Durchgangsgewinde For through hole threads Pour trous débouchants Per fori passanti		Vaporisiert Steam treatment Vaporisé Vaporizzato		Anzahl Schneiden Number of teeth Nombre de dents Numero dei denti
	Für Grundlochgewinde ≤1,5xD For blind hole threads ≤1,5xD Pour trous borgnes ≤1,5xD Per fori ciechi ≤1,5xD		Titan-Nitrid Titanium nitride Nitrure de titane Nitruro di titanio		Seite Page Page Pagina
	Für Grundlochgewinde ≤2,5xD For blind hole threads ≤2,5xD Pour trous borgnes ≤2,5xD Per fori ciechi ≤2,5xD		Titan-Carbonitrid Titanium carbonitride Carbonitrure de titane Carbonitruro di Titanio		Artikel-Nummer Order number Numéro d'article Numero di articolo
	Für Grundlochgewinde ≤3xD For blind hole threads ≤3xD Pour trous borgnes ≤3xD Per fori ciechi ≤3xD		Titan-Aluminiumnitrid Titanium aluminium nitride Nitrure de titane-aluminium Nitruro di Titanio-Alluminio		Warengruppe Product group Group d'article Gruppo merceologico



#### 1. Angebot und Auftrag

Unsere Angebote erfolgen freibleibend. Aufträge und mündliche Vereinbarungen haben nur Gültigkeit, wenn sie von uns schriftlich bestätigt sind. Die Einkaufs- und Geschäftsbedingungen unserer Abnehmer werden von uns nicht anerkannt, auch wenn wir nicht widersprochen haben.

#### 2. Preise

Die Grundpreise in unseren jeweils gültigen Listen sind unverbindliche Preisempfehlungen ohne Mehrwertsteuer. Sie gelten ab Bad Homburg und schließen die Kosten für Verpackung, Fracht, Porto und Wertsicherung nicht ein. Es werden jeweils die am Tage der Lieferung gültigen Preise und Zuschläge berechnet.

#### 3. Zahlungsbedingungen

Die Zahlung ist innerhalb von 30 Tagen nach Rechnungsdatum ohne Abzug oder innerhalb von 10 Tagen mit 2% Skonto zu leisten. Bei verspäteter Zahlung sind wir berechtigt, Verzugszinsen von 5 Prozentpunkten über dem jeweiligen Basiszinssatz zu verlangen. Wechselspesen gehen zu Lasten des Käufers.

#### 4. Eigentumsvorbehalt

- a) Wir behalten uns das Eigentum an allen von uns gelieferten Waren bis zur Erfüllung sämtlicher Forderungen aus der Geschäftsverbindung vor. Bei laufender Rechnung gilt der Eigentumsvorbehalt für die zu sichernde Saldoforderung.
- b) Der Käufer tritt uns im Voraus alle Forderungen aus einem Weiterverkauf der Ware oder sonstigen Geschäften mit der Ware sicherungshalber ab. Wird unsere Ware zusammen mit anderer Ware verkauft, gilt die Abtretung der Forderung nur in Höhe des Wertes unserer Vorbehaltsware.
- c) Der Käufer ist zum Verkauf der Ware und zur Einziehung der abgetretenen Forderung ermächtigt. Wir werden die Forderung nicht einziehen, solange der Käufer seinen Zahlungsverpflichtungen nachkommt. Solange unsere Forderungen nicht erfüllt sind, hat der Käufer die eingezogenen Beträge gesondert aufzubewahren und an uns abzuführen. Auf Verlangen hat der Käufer uns die Drittschuldner der abgetretenen Forderungen und die Forderungshöhe bekanntzugeben, den Drittschuldnern die Abtretung anzuzeigen und uns die notwendigen Unterlagen herauszugeben.
- d) Bei Nichteinhaltung der Zahlungsbedingungen, bei Wechselprotesten und Nichteinlösung von Schecks erlöschen die Rechte des Käufers zur Veräußerung und zum Einzug der abgetretenen Kaufpreisforderung. Wir sind in diesem Falle berechtigt, die von uns gelieferte Ware in unseren Besitz zu nehmen. Ein Rücktritt vom Vertrag ist darin nur zu erblicken, wenn wir dies ausdrücklich erklären. Alle Kosten einer Rücknahme gehen zu Lasten des Käufers. Von eventuellen Pfändungen sind wir unter Bekanntgabe des Pfandgläubigers sofort zu unterrichten. Interventionskosten gehen zu Lasten des Käufers.
- e) Auf Verlangen des Käufers geben wir voll bezahltes Liefergut nach unserer Wahl frei, wenn der Wert der uns gegebenen Sicherheit unsere Forderungen um mehr als 20% übersteigt.

#### 5. Lieferung

Lieferzeiten werden so zuverlässig wie möglich eingehalten, sind jedoch nicht verbindlich.

#### 6. Versand

Der Versand erfolgt auf Gefahr des Käufers. Die Verpackung wird zu Selbstkosten berechnet. Wenn vom Käufer gewünscht, kann die leere Verpackung nach Gebrauch zurückgegeben werden. Die Kosten für den Rücktransport trägt der Käufer.

#### 7. Sachmängel

Mängelansprüche bestehen nicht bei ungeeigneter oder unsachgemäßer Verwendung, fehlerhafter Montage bzw. Inbetriebsetzung, natürlicher Abnutzung, fehlerhafter oder nachlässiger Behandlung u.ä..

#### 8. Haftung

Für Schäden – gleich aus welchem Rechtsgrund – haftet der Verkäufer nur bei Vorsatz, grober Fahrlässigkeit, schuldhafter Verletzung von Leben, Körper, Gesundheit und in sonstigen Fällen zwingender Haftung wie z.B. nach dem Produkthaftungsgesetz.

#### 9. Verjährung

Sachmängelansprüche und alle sonstigen Ansprüche des Käufers – aus welchem Rechtsgrund auch immer – verjähren in 12 Monaten, soweit nicht rechtlich zwingend längere Fristen gelten.

#### 10. Rücknahme

Zur Rücknahme bestellter und richtig gelieferter, mangelfreier Ware sind wir nicht verpflichtet.

Erklären wir uns im Einzelfall schriftlich mit der Rücknahme einverstanden, berechnen wir pauschal 20% des Netto-Verkaufspreises, mindestens jedoch EUR 15,00 zzgl. MwSt als Wiedereinlagerungs- bzw. Warenrücknahmekosten.

Sonderanfertigungen oder speziell beschriftete oder gekennzeichnete Artikel sind von einer Rücknahme ausgeschlossen.

#### 11. Erfüllungsort, Gerichtsstand, Allgemeines

Für Lieferung und Zahlung ist Bad Homburg Erfüllungsort. Gerichtsstand ist Frankfurt am Main. Für das Rechtsverhältnis gilt deutsches Recht. Die Unwirksamkeit einzelner Bestimmungen hat auf die Gültigkeit der übrigen Bestimmungen keinen Einfluß.

#### WEXO® Präzisionswerkzeuge GmbH

Siemensstraße 13

61352 Bad Homburg

*For further languages please visit our website: [www.wexo.com](http://www.wexo.com)*

*Pour d'autres langues visitez notre site: [www.wexo.com](http://www.wexo.com)*

*Per altre lingue, visitate: [www.wexo.com](http://www.wexo.com)*



## **WEXO® Präzisionswerkzeuge GmbH**

---

Siemensstraße 13, 61352 Bad Homburg (Germany)  
T +49(0)6172 106-206, F +49(0)6172 106-213  
<http://www.wexo.com> · E-Mail: [verkauf@wexo.com](mailto:verkauf@wexo.com)